

Haier

**Haier**  
Inspired Living

WATER HEATER CATALOG



# WATER HEATER

GLOBAL HOME WATER SCENARIO SOLUTIONS



Global Home Water Scenario Solutions 



**ADDRESS**

No.1 Haier Road, Qingdao 266101 P.R. China

**WEBSITE**

[www.haier.com](http://www.haier.com)



The specifications, designs and information in this brochure are subject to the actual products. Haier reserves the right to make changes without any notice.



# CONTENTS

<b>01</b>	<b>Branding</b>
01	Haier Brand Story
03	Haier Milestone
05	Global Position
07	Global Network
09	Layout of Global Smart Manufacturing Factories
11	Global R&D Strength
13	Market Performance
15	License & Certificate
<b>17</b>	<b>Product</b>
17	Product Category
19	Electric Storage
39	Heat Pump



## Brand story

The Internet era is a diverse and unconventional time, where “one size fits all” products and solutions simply aren’t enough. Customers want to be treated as individuals and respected for who they are.

Everyone wants their unique lifestyle acknowledged. That is why Haier listens closely to you in order to gain a genuine understanding of what is going on in your life and what is on your mind. So each of you can get the smart home experience you deserve: be it simple, sophisticated, organized or enjoyable.

As a worldwide industry leader, Haier innovates beyond products and solutions and turns the organization into a wholly connected platform. In doing so, internal and external resources are connected quickly and easily. We believe only by doing so, we can best meet our consumers’ expectations in this rapidly evolving world.

Be part of the Haier Network. Create new possibilities.

## 1984

Foundation of Haier.



## 1985

Haier smashed 76 sub-standard Haier refrigerators, which was afterwards seen as the warning bell of quality in Haier's history.



Haier introduced advance technologies and facilities from German Liebherr, and then produced the first generation of "four star" refrigerators in Asia.



## 1988

Haier scored the highest in the refrigerator quality evaluation and won the first gold medal in China's refrigerator history.



## 1991

Haier merged Qingdao Electric Freezer Factory and Qingdao Air Conditioner Factor, and entered the strategic stage of diversified development.



## 1998

"Haier culture activating stunned fish" was included into the case library of Harvard Business School. CEO Zhang became the first Chinese entrepreneur who took the podium at Harvard.



## 1999

"Haier culture activating stunned fish" was included into the case library of Harvard Business School. CEO Zhang became the first Chinese entrepreneur who took the podium at Harvard.



## 2000

"Haier culture activating stunned fish" was included into the case library of Harvard Business School. CEO Zhang became the first Chinese entrepreneur who took the podium at Harvard.



## 2005

"Haier culture activating stunned fish" was included into the case library of Harvard Business School. CEO Zhang became the first Chinese entrepreneur who took the podium at Harvard.



## 2013

Haier Global Forum on Business Model Innovation was held in Qingdao, and Haier released its new brand strategy and new brand image in the networking strategy stage.



Haier and Alibaba reached strategic cooperation. Based on their respective advantages, the two sides will work together to create a new set of systems and standards for logistics, distribution, installation and service of home appliances and large goods.



## 2016

Haier showed the world's first intelligent manufacturing cloud platform COSMO based on the interconnected factory model at the first World's Intelligent Manufacturing Summit.



## 2018

Haier as the world's first IoT ecosystem brand, was listed into the world's top 500 brands, ranking 41st in the world.



At the celebration of the 40th anniversary of the reform and opening up, CEO Zhang was awarded the title of "reform pioneer" by CPC Central Committee and State Council as an outstanding entrepreneur representative focusing on enterprise management innovation.



## 2019

Haier became the first and only IoT ecosystem brand entering the global top 100 brands in the history of BrandZ.



Haier Smart Home Co., Ltd. once again ranked among the Fortune Global 500 with its global landing of smart home ecological brand, moving up 51 ranks compared to last year.



## 2020

According to the latest data of Euromonitor International, Haier ranked No.1 in global retail sales of large household appliances for the 11th time.



Haier smart home was successfully listed on the main board of the stock exchange of Hong Kong Limited, building a global layout of a + D + H capital market



## 2022

According to the latest data of Euromonitor International, Haier ranked No.1 in global retail sales of large household appliances for the 13 times.



# Haier Global Position

Haier has been honored as the world's largest home appliance brand with a 10.5% retail volume share in 2017 marketing for eight consecutive years. (Data source:Euromonitor).

Global Market Share

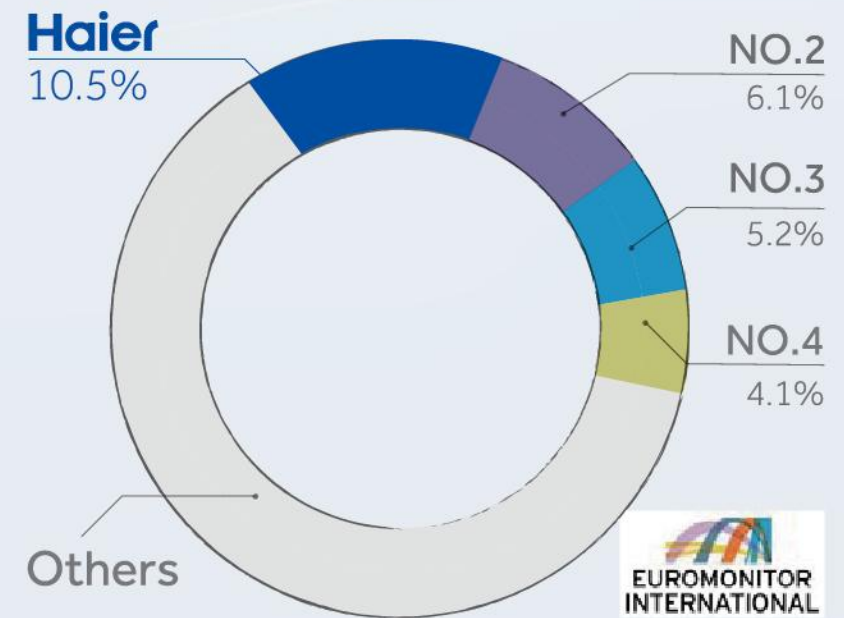

Global Sales Revenue

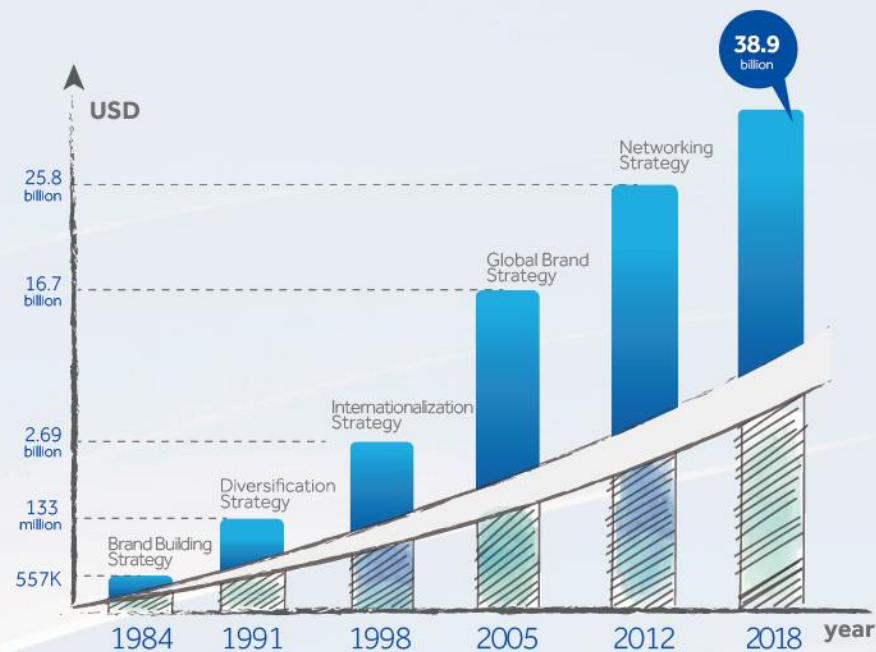

Established in 1984, Haier is the **World's NO.1** major appliance brand. In the Internet age, Haier aims to become a Networked Enterprise and its global revenue reaching **38.9 billion** USD in 2018.

# Haier Global Network

Haier has built up its infrastructures globally to meet the customers' quick evolving demands, including R&D centers, production facilities, trading companies and sales networks etc.

Haier's five R&D centers around the world have forged strategic partnerships with first-class suppliers, research institutions, and prestigious universities to create an innovative ecosystem composed of internal and external scientists and engineers connected by virtual and physical networks.



# Haier Water Heater Global Smart Manufacturing

Heat pump  
Gas water heater



USA South Carolina GEA factory  
(Under construction)  
Plan to begin production in 2022  
and annual production capacity  
500,000 units

Electric water heater  
Purifier



Russia water heater and purifier  
factory (Under construction)  
Investment 460 million RMB, plan  
to begin production in 2023 and  
annual production capacity 1  
million units

Electric water heater  
Solar energy



Electric water heater Solar energy

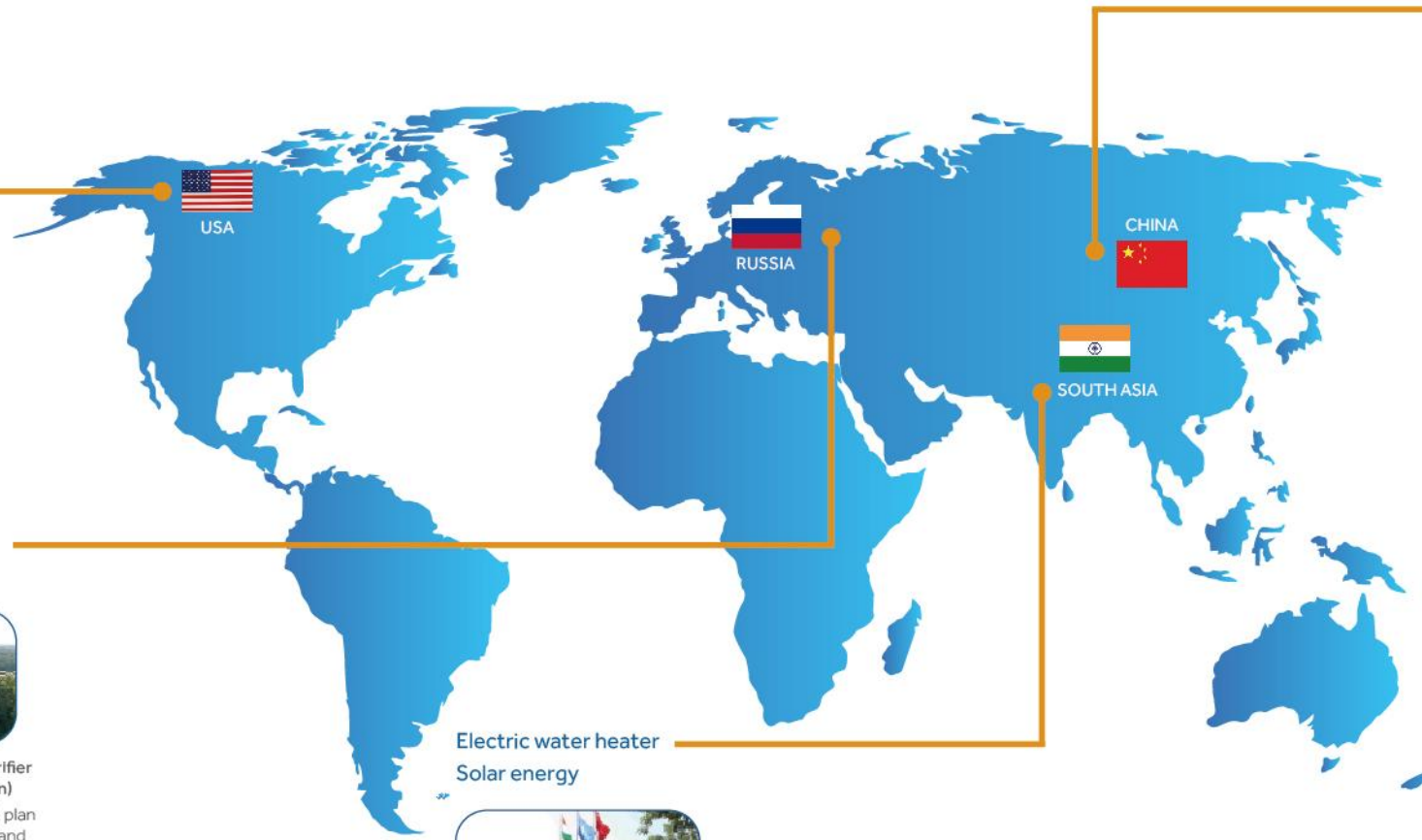

Electric WH、 Gas WH、 Solar WH、 Heat  
Pump、 Gas Boiler、 Purifier



Wuhan factory



Qingdao factory



Qingdao(Jiaonan)  
factory



Qingdao(Jiaonan)



Zhengzhou factory  
(Heat pump)



Sino-German industrial  
park factory(Solar)



Qingdao  
purifier factory  
(Jimo)



Qingdao  
Sino-German factory  
(Electric water heater)

- Commissioning from Apr 2021
- The 1st term production capacity 2 million units
- Key parts self-made to control cost

- Under construction, investment 1.65 billion RMB
- Begin production from 2024 and annual capacity 8 million units

China **8** domestic factories and **3** overseas factories, annual production **35** million units

The 1st batch of  
"Highly automatic factory"  
in China

1

Haier is the only Chinese brand



19

Totally 19 companies  
in the world from 2013-2020



# Haier Water Heater Global R&D Strength—Integrate World Resource and Share International Platform

Global 10 R&D Centers HOPE NO.1 Resource in the world





# Haier Electric Water Heater: Market Leader

**Global No.1** manufacturer & seller for

**10** consecutive years



# Haier Heat Pump: Best Seller Globally For Consecutive 3 Years



**NO.1**



# Haier Water Heater: License & Certificate



Safety



Harmful substance



Harmful substance



Safety(for EWH)



Safety+Performance(for HPWH)



# Product category

Our products can meet your water needs under different scenarios

## ● Electric water heater

### Flat ▼



### Square Small ▼



### Round Vertical ▼



- Shock Proof
- Titanium Heating Element
- Double Tank
- Max Water Volume
- ECO-SMART
- Anti-Bacteria

- Shock Proof
- UMC Tank
- U-Turn Flow Technology
- Incoloy Heating Element

- Mo+ Incoloy Heating Element
- ErP Class B
- Precise Electronic Control
- Eco-smart
- Available Hot Water Prompt

## ● Heat pump

### Monobloc ▼



### Split ▼



- PV
- Easy To Install
- ECO
- Micro-channel Condenser
- Fast heating
- Slim body

- Micro-channel Condenser
- Fast heating
- Eco comfort
- Intelligent defrost module



**ELECTRIC STORAGE**   
WATER HEATER

## TF7 Core Parts Assembly View

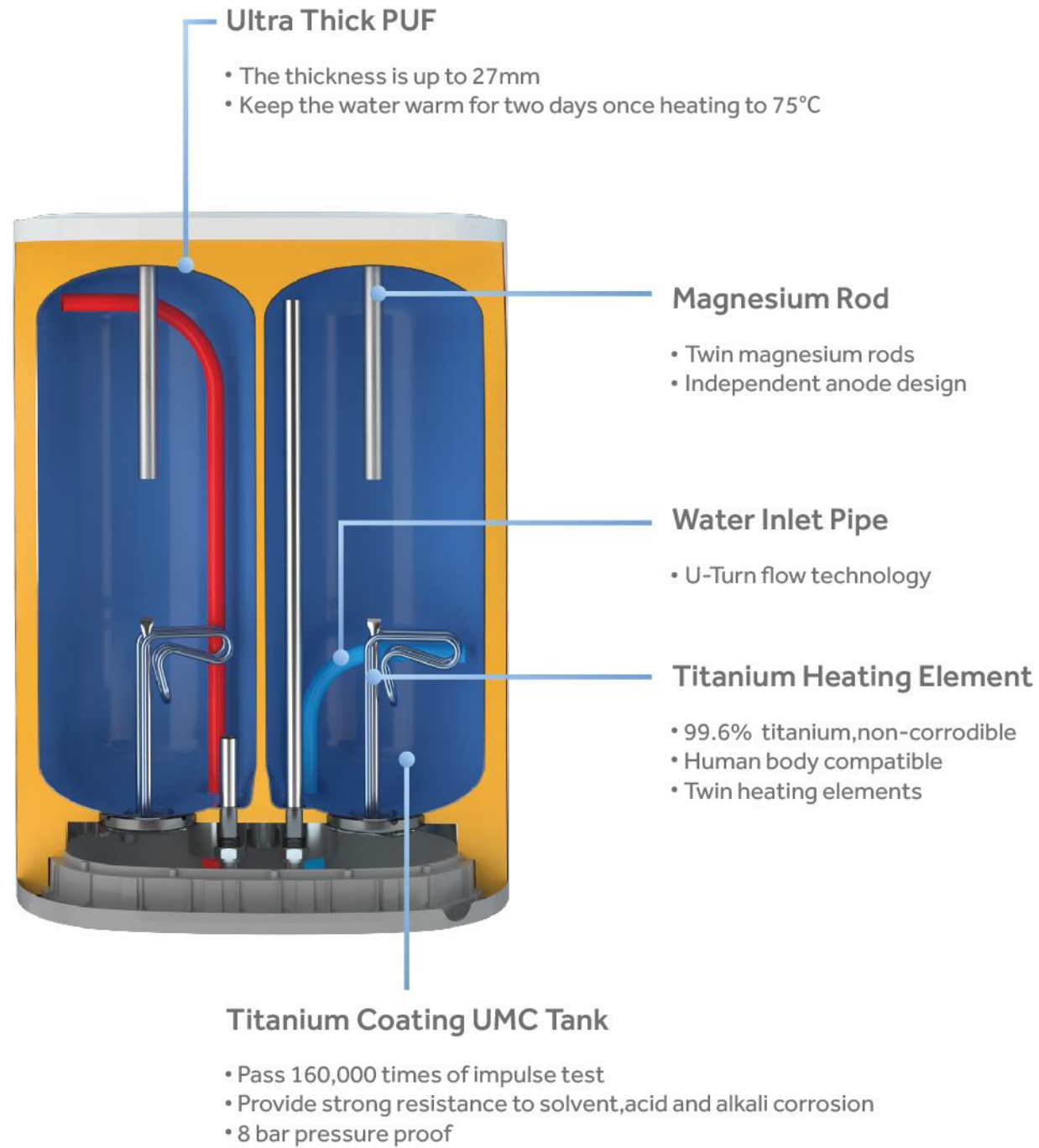

## VH3 Core Parts Assembly View

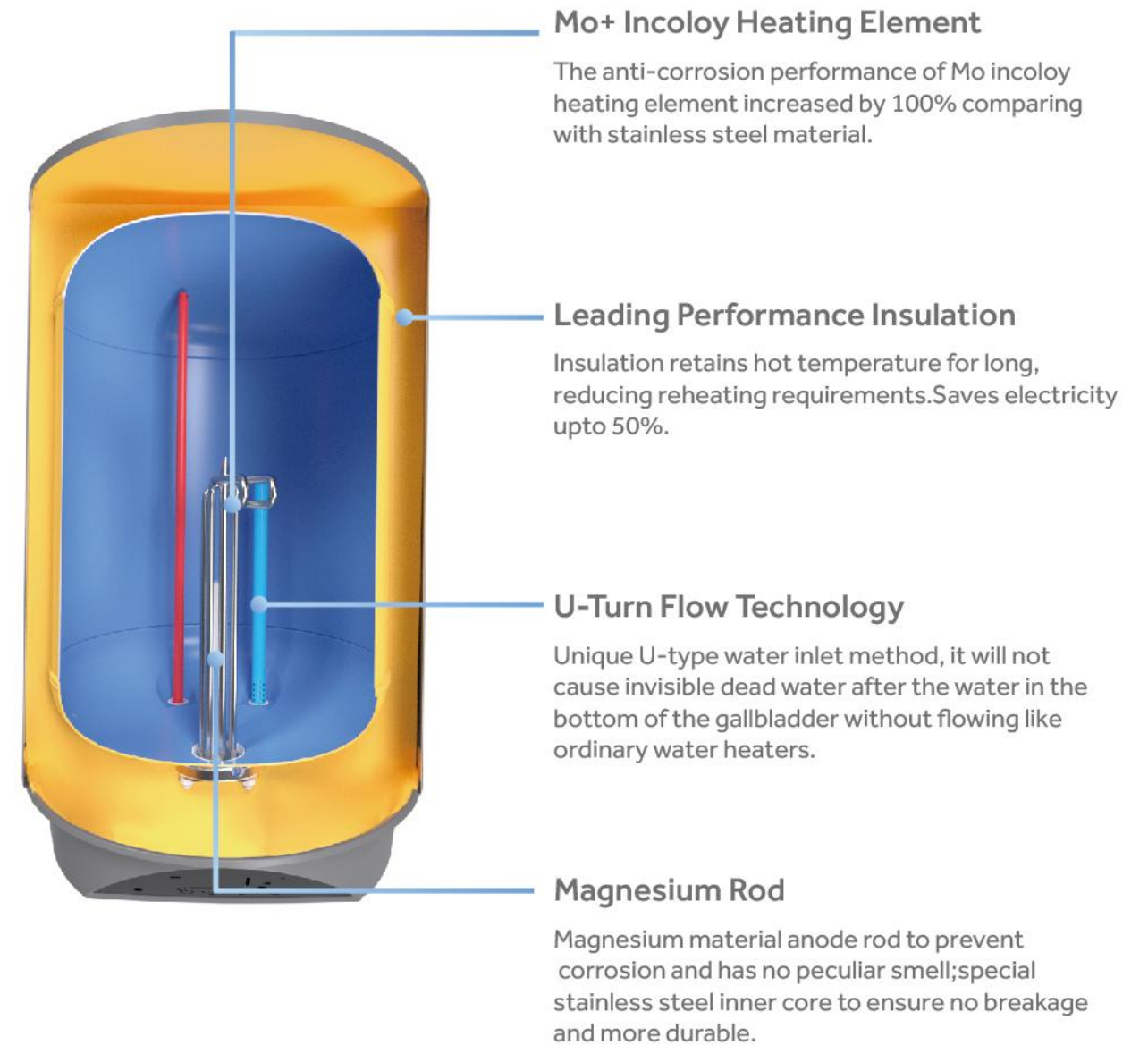

# Quality

## • Inner Tank

### Tough UMC Inner Tank

Only water heater with Ultra Micro Coating tank, conforms to the Germany DIN Standard, extra thick special steel sheet for longer life. It is proved to pass 160,000 times of impulse test.

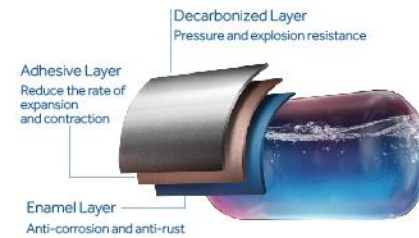

## • Heating Element

### Titanium Heating Element

Titanium is a kind of material can be used in aerospace industry, our heating element is made of titanium (made of 99.6% pureness titanium material) so that will have very good function of anti-corrosion, high intensity and high temperature resistance. It is not necessary for the users to change the magnesium rod on time.



### Mo+ Incoloy Heating Element

The anti-corrosion performance of Mo heating element is 4 times than normal material heating element (stainless steel 316L).



### Magnesium Rod

Magnesium material anode rod to prevent corrosion and has no peculiar smell, every cubic meter of tank surface has minimum 200g magnesium rod.

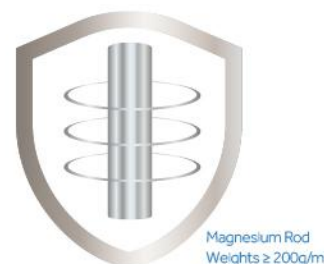

## Liquid Expansion Thermostat

More accurate and faster action, which means higher reliability.



## Copper Water Inlet/Outlet

Copper water inlet/outlet, good performance of corrosion resistance and no need to install dielectric joints.



# Comfortable



## Enjoy Healthy Shower with BPS

By choosing the BPS mode, the Water Heater heats up the water at 80°C by which legionella bacteria starts die off and sterilization rate is 99.99%.



## U-Turn Flow Technology

Unique U-type water inlet method, it will not cause invisible dead water after the water in the bottom of the gallbladder without flowing like ordinary water heaters. It will increase the water output volume by 20%.

## Convenient

### Power-off Memory

The intelligent power-off memory function will automatically memorize the data during working, it can resume the data when it is power-on.

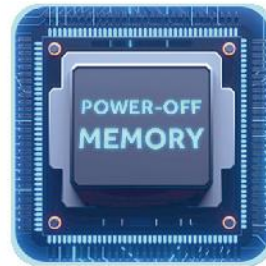

### Bracket

Easy to install under any environment, firm installation and not falling off, convenient removal if necessary.



## Energy Saving

### Eco Mode

ECO MODE can automatically memorize user's habit to do smart heating, saving energy up to 18%.



### Leading Performance Insulation

Eco-friendly material (polyurethane foam) insulation layer can keep the water warmth for long time.

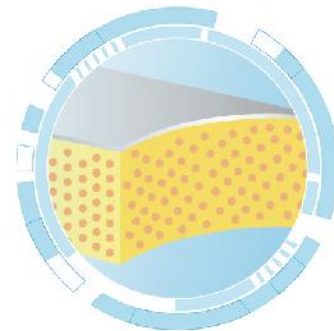

## Safe

### Safe voltage to prevent shock

By physically converting the rated voltage lower to the safe voltage, it's the unique water heater that ensures this machine safety under the following conditions:

- ✓ No earthing cases
- ✓ Faulty earthing cases
- ✓ All electric leakage from the water heater

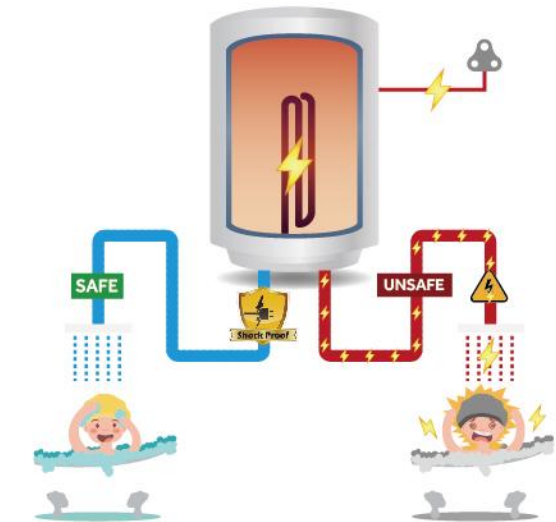

## Appearance

### Compact Design

More compact by 24%-28%, the depth is only 28-30cm, its flexibility can accommodate to any installation environment.



## Fast heating

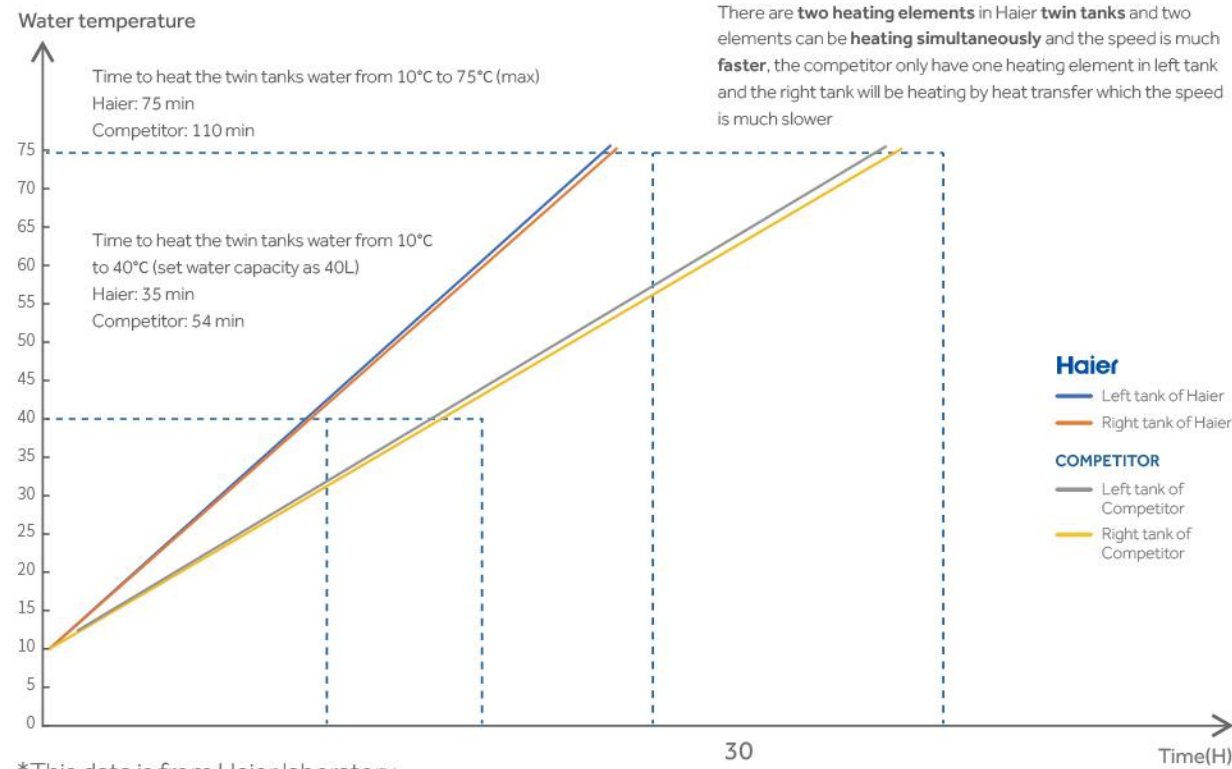

## Thermal insulation

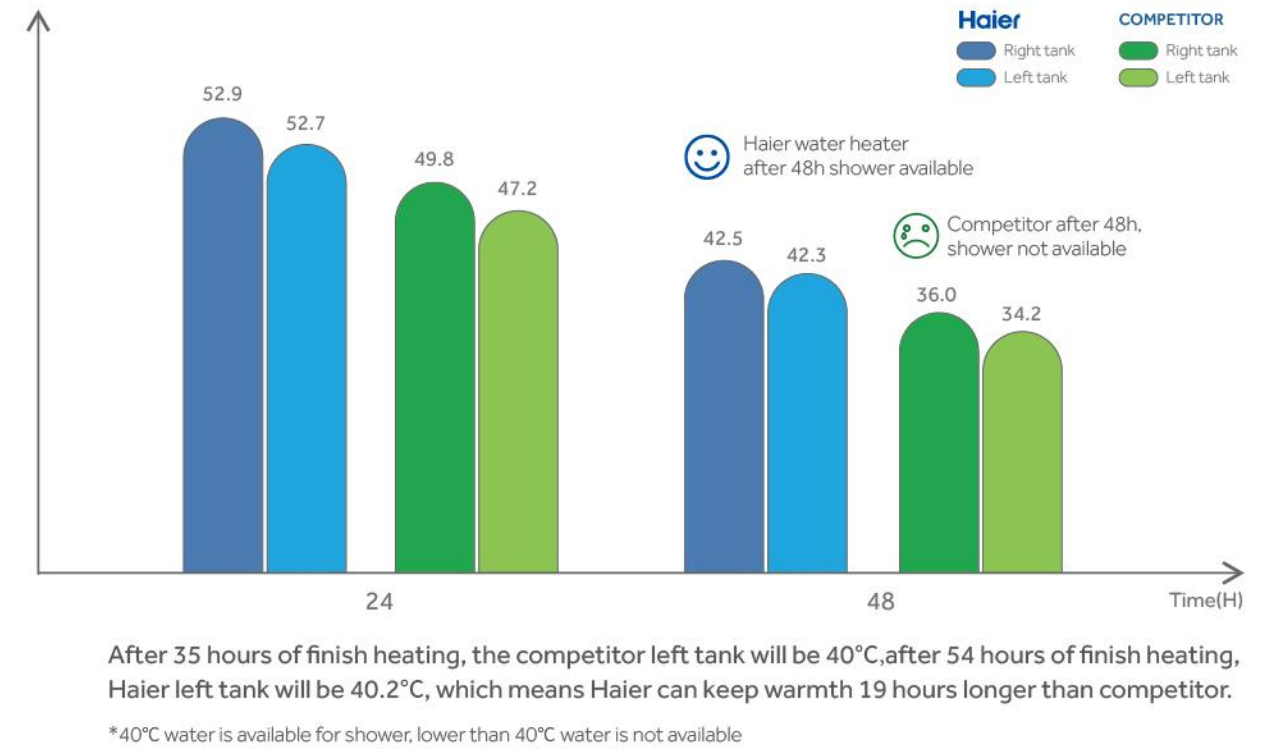

## Anti-corrosion

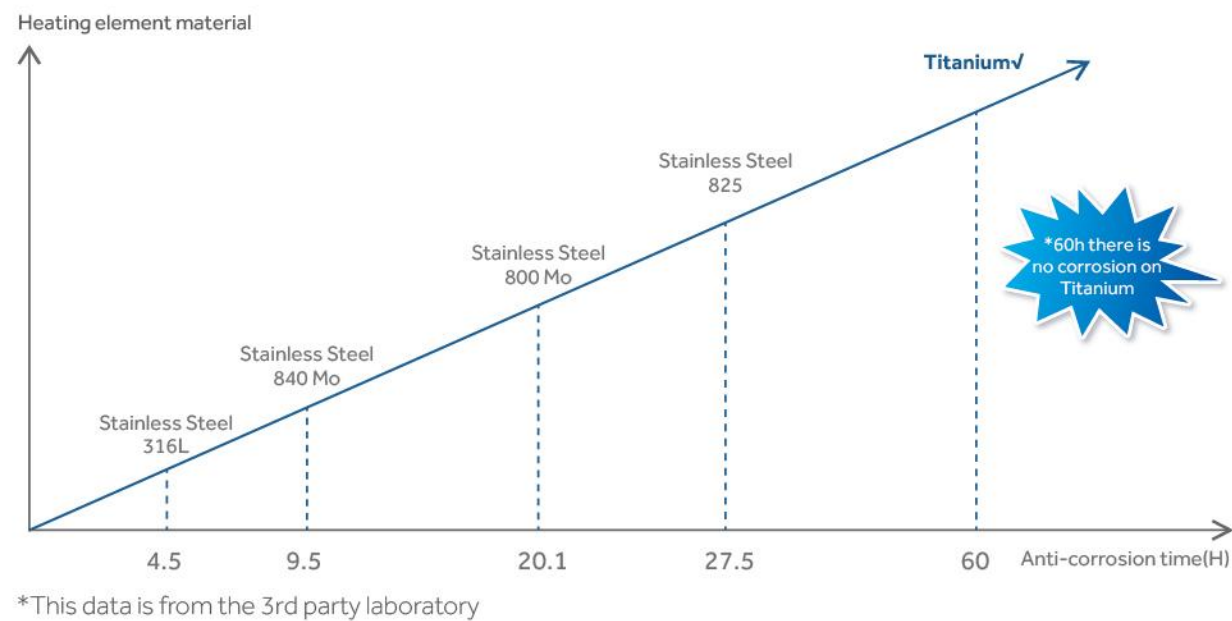

## Energy saving

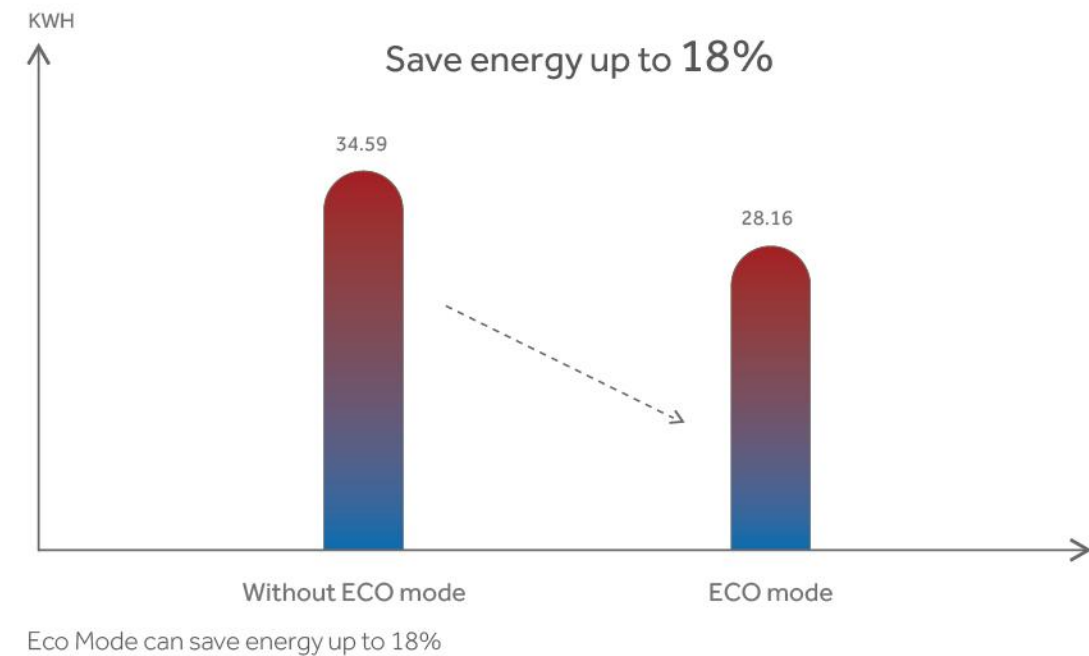



# Installation

Figure I Installation Schematic-Vertical Installation(TF7 Series)

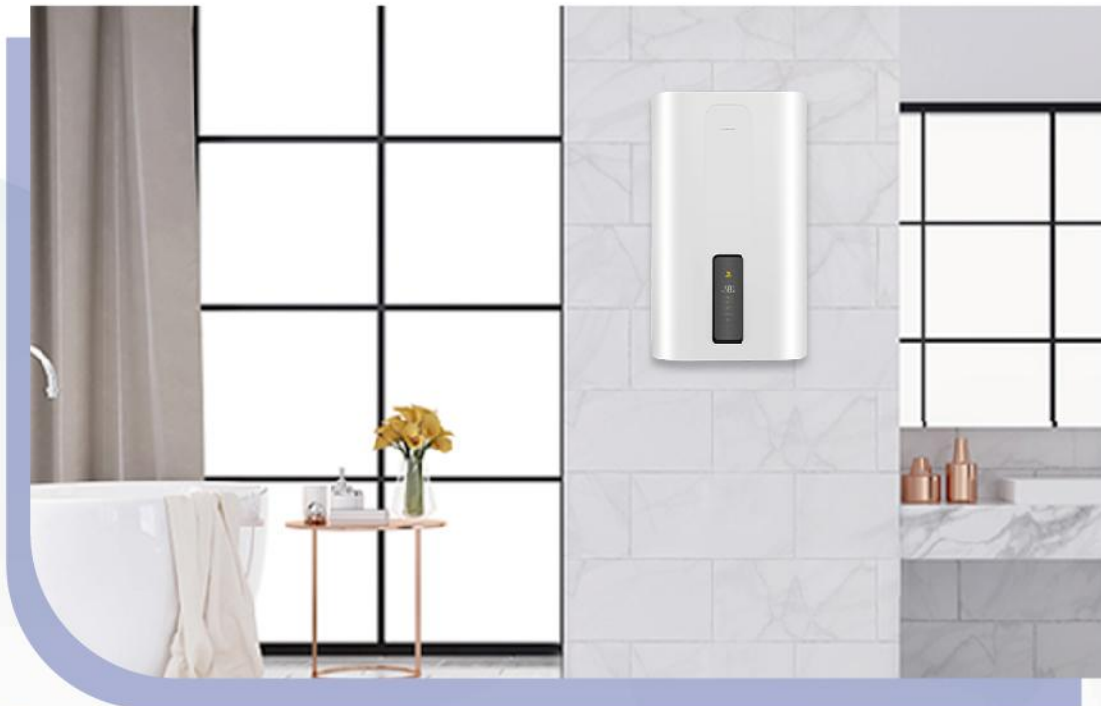
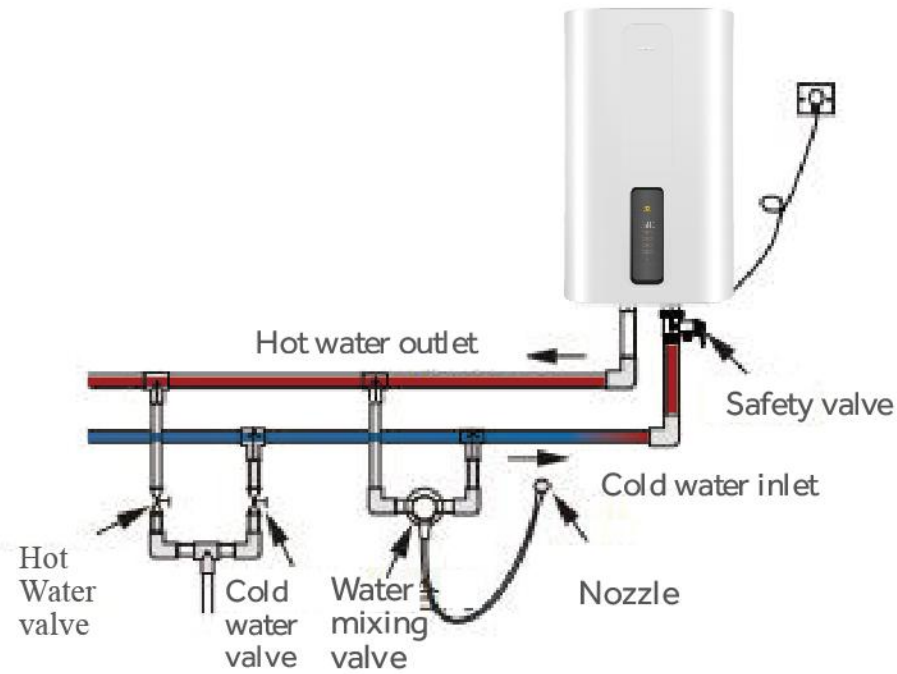
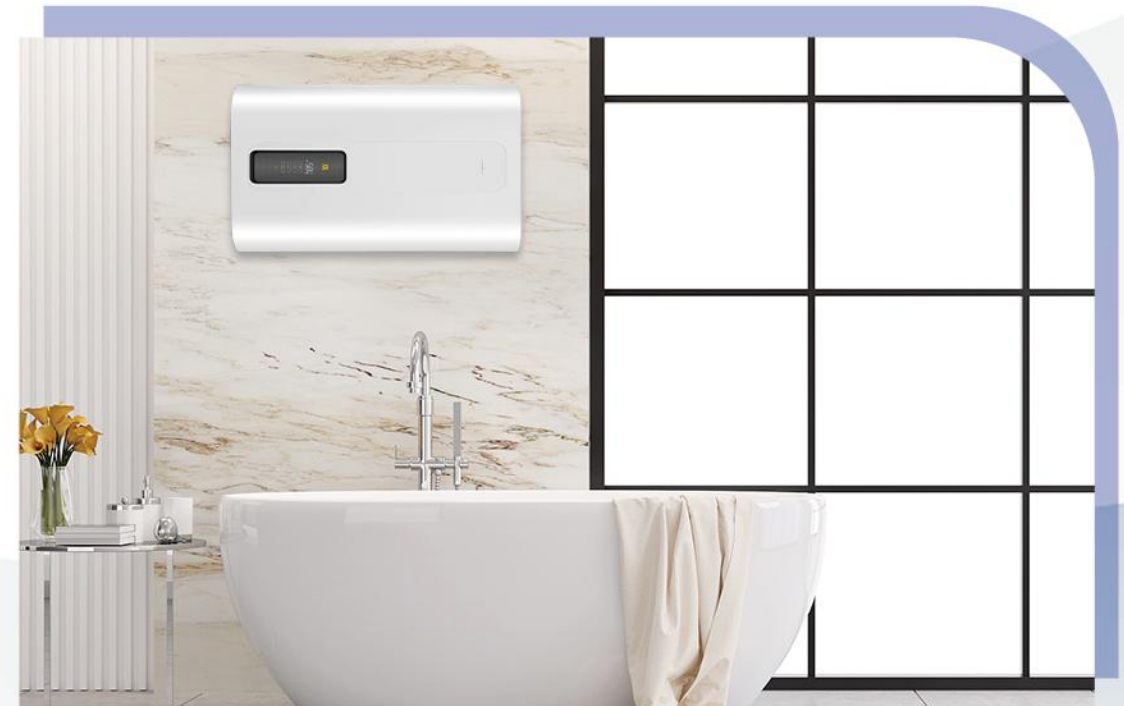
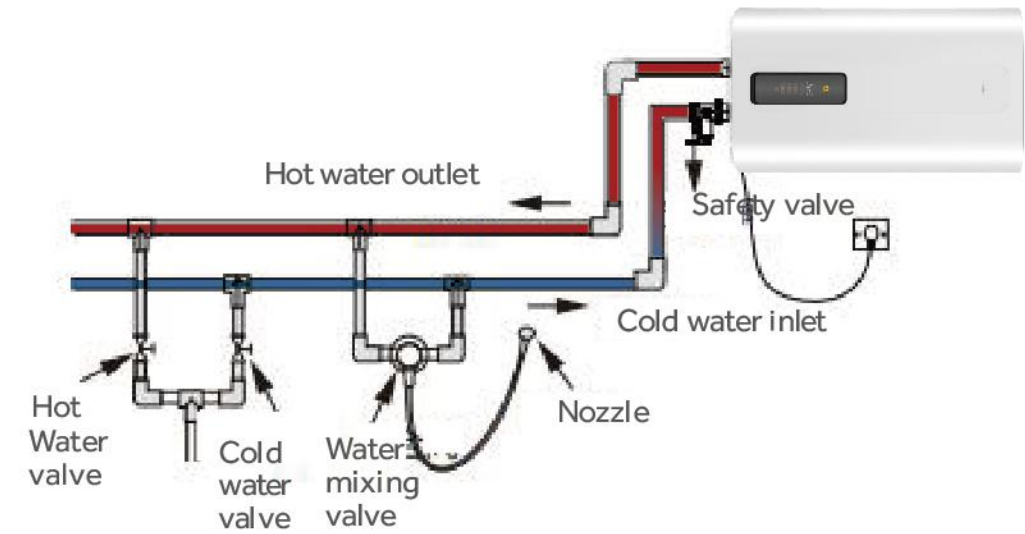

Figure IV Installation Schematic-Horizontal Installation(for TF7 Series only),it must be installed according to the schematic



# Scenarios



Cabinet



Bathroom



Balcony



## ES50/80V-TF7(EU)



- Shock proof ensures a safe shower for your family
- Ti heating element, non-corrodible and compatible with human body
- Twin power heating
- ECO MODE can automatically memorize user's habit to do smart heating, saving cost by higher efficiency
- By choosing the BPS mode, the Water Heater heats up the water at 80°C to inhibit the bacteria
- Suitable for Horizontal & Vertical Installation

Model	ES50V-TF7(EU)	ES80V-TF7(EU)
Installation type	Universal	Universal
Control method	Electronic	Electronic
Capacity(L)	47	74
Material of Inner tank	Enamelled steel	Enamelled steel
Material of Outer body	PCM steel	PCM steel
Material of Heating Element	Titanium	Titanium
Rated voltage(V)/Frequency(Hz)	220-240/50	220-240/50
Rated power(W)	1500/1500	1500/1500
Rated temperature(°C)	75	75
Rated pressure(Bar)	8	8
Tap water pressure(Bar)	≥0.05	≥0.05
Water-proof grade	IPX4	IPX4
Product dimensions H/W/D(mm)	745*530*320	1070*530*320
Packing dimensions H/W/L(mm)	613*411*857	613*411*1177
Net weight(kg)	25	34
Gross weight(kg)	29	40
Load qty.40HQ	315	210
Energy Class	ErpB	ErpB

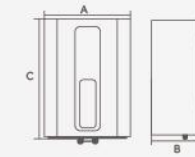

\*Dimensions (mm)

Model	A	B	C
ES50V-TF7(EU)	530	320	745
ES80V-TF7(EU)	530	320	1070



## Control Panel



## Elegant Appearance

| Three-dimensional structure design





## ES50/80V-VH3(EU)



- The anti-corrosion performance of Mo incoloy heating element increased by 100% comparing with stainless steel material
- Erp Class B energy class
- Control panel with electric display, clear and fashional
- Heat the water to 55°C which meets the basic daily demands, while reducing scaling, saving energy and increase the service life of heating element
- Specialized designed dial real-time displays the volume of remaining water

Model	ES50V-VH3(EU)	ES80V-VH3(EU)
Installation type	Vertical	Vertical
Control method	Electronic	Electronic
Capacity(L)	47	75
Material of Inner tank	Enamelled steel	Enamelled steel
Material of Outer body	SPCC coating	SPCC coating
Material of Heating Element	Incoloy 310s+Mo	Incoloy 310s+Mo
Rated voltage(V)/Frequence(Hz)	220-240/50	220-240/50
Rated power(W)	1500	1500
Rated temperature(°C)	75	75
Rated pressure(Bar)	8	8
Tap water pressure(Bar)	≥0.05	≥0.05
Water-proof grade	IPX4	IPX4
Product dimensions H/W/D(mm)	410*421*686	410*421*996
Packing dimensions H/W/L(mm)	485*495*750	485*495*1060
Net weight(kg)	18	26
Gross weight(kg)	21	30
Load qty.40HQ	376	240
Energy Class	ErpB	ErpB

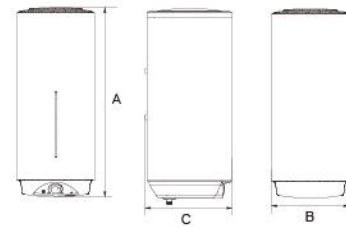

\*Dimensions (mm)

Model	A	B	C
ES50V-VH3(EU)	686	410	421
ES80V-VH3(EU)	996	410	421



## Control Panel

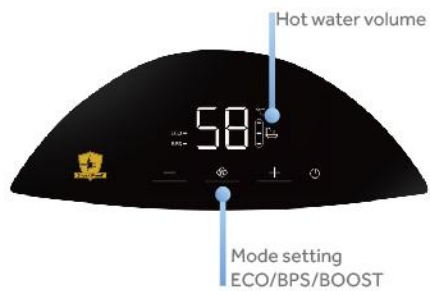

## Elegant Appearance



## ES30/50/80/100V-A3(EU)



- Shock proof ensures a safe shower for your family
- The anti-corrosion performance of Mo incoloy heating element increased by 100% comparing with stainless steel material
- Real-time hot water temperature display
- UMC structure with 850°C treatment, pass the 160,000 cycles of pressure test
- Unique U-type water inlet method, it will not cause invisible dead water after the water in the bottom of the gallbladder without flowing like ordinary water heaters

Model	ES30V-A3(EU)	ES50V-A3(EU)	ES80V-A3(EU)	ES100V-A3(EU)
Installation type	Vertical	Vertical	Vertical	Vertical
Control method	Mechanical	Mechanical	Mechanical	Mechanical
Capacity(L)	30	50	80	100
Material of Inner tank	Enamelled steel	Enamelled steel	Enamelled steel	Enamelled steel
Material of Outer body	SPCC coating	SPCC coating	SPCC coating	SPCC coating
Material of Heating Element	Incoloy 310s+Mo	Incoloy 310s+Mo	Incoloy 310s+Mo	Incoloy 310s+Mo
Rated voltage(V)/Frequence(Hz)	220-240/50	220-240/50	220-240/50	220-240/50
Rated power(W)	1500	1500	1500	1500
Rated temperature(°C)	75	75	75	75
Rated pressure(Bar)	8	8	8	8
Tap water pressure(Bar)	≥0.05	≥0.05	≥0.05	≥0.05
Water-proof grade	IPX4	IPX4	IPX4	IPX4
Product dimensions H/W/D(mm)	390*400*447	390*400*650	390*400*930	390*400*1160
Packing dimensions H/W/L(mm)	475*459*491	475*459*666	475*459*966	475*459*1189
Net weight(kg)	12	15	24	30
Gross weight(kg)	14	17	27	33
Load qty.40HQ	610	473	314	266
Energy Class	ErpC	ErpC	ErpC	ErpC

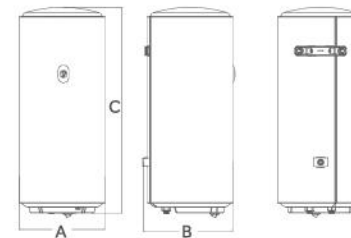

\*Dimensions (mm)

Model	A	B	C
ES30V-A3(EU)	390	400	447
ES50V-A3(EU)	390	400	650
ES80V-A3(EU)	390	400	930
ES100V-A3(EU)	390	400	1160

## Elegant Appearance

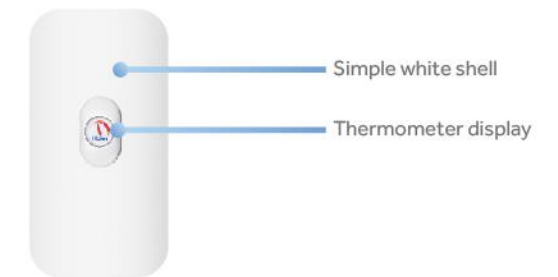



## ES10V-Q1/Q2(EU)



- Shock proof ensures a safe shower for your family
- ABS body is Anti-corrosion, durable and good energy saving
- Only water heater with Ultra Micro Coating tank, conforms to the Germany DIN Standard, extra thick special steel sheet for longer life
- Unique U-type water inlet method, it will not cause invisible dead water after the water in the bottom of the gallbladder without flowing like ordinary water heaters
- Incoloy Heating Element has best performance under high temperature and pressure conditions

Model	ES10V-Q1(EU)	ES10V-Q2(EU)
Installation type	Over tank	Under tank
Control method	Mechanical	Mechanical
Capacity(L)	10	10
Material of Inner tank	Enamelled steel	Enamelled steel
Material of Outer body	ABS	ABS
Material of Heating Element	Incoloy840	Incoloy840
Rated voltage(V)/Frequence(Hz)	220-240/50	220-240/50
Rated power(W)	1650	2150
Rated temperature(°C)	75	75
Rated pressure(Bar)	7.5	7.5
Tap water pressure(Bar)	≥0.05	≥0.05
Water-proof grade	IPX4	IPX4
Product dimensions H/W/D(mm)	350*270*350	350*270*350
Packing dimensions H/W/L(mm)	416*336*462	416*336*462
Net weight(kg)	8	8
Gross weight(kg)	10	10
Load qty.40HQ	1100	1100
Energy Class	ErpB	ErpB

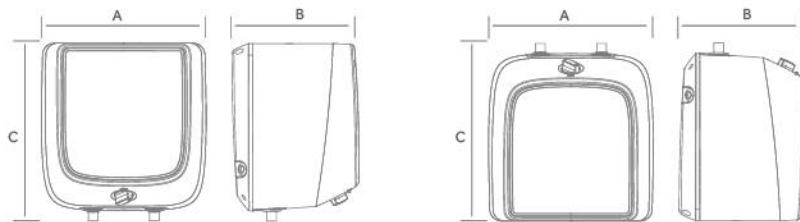

\*Dimensions (mm)

Model	A	B	C
ES10V-Q1(EU)	350	270	350
ES10V-Q2(EU)	350	270	350



## ES15V-Q1/Q2(EU)



- Shock proof ensures a safe shower for your family
- Only water heater with Ultra Micro Coating tank, conforms to the Germany DIN Standard, extra thick special steel sheet for longer life
- Unique U-type water inlet method, it will not cause invisible dead water after the water in the bottom of the gallbladder without flowing like ordinary water heaters
- Incoloy Heating Element has best performance under high temperature and pressure conditions

Model	ES15V-Q1(EU)	ES15V-Q2(EU)
Installation type	Over tank	Under tank
Control method	Mechanical	Mechanical
Capacity(L)	15	15
Material of Inner tank	Enamelled steel	Enamelled steel
Material of Outer body	PS	PS
Material of Heating Element	Incoloy310s+Mo	Incoloy310s+Mo
Rated voltage(V)/Frequence(Hz)	220-240/50	220-240/50
Rated power(W)	2000	2000
Rated temperature(°C)	75	75
Rated pressure(Bar)	8	8
Tap water pressure(Bar)	≥0.05	≥0.05
Water-proof grade	IPX4	IPX4
Product dimensions H/W/D(mm)	327*333*402	327*333*402
Packing dimensions H/W/L(mm)	394*389*477	394*389*477
Net weight(kg)	9	9
Gross weight(kg)	10	10
Load qty.40HQ	960	960
Energy Class	ErpB	ErpB

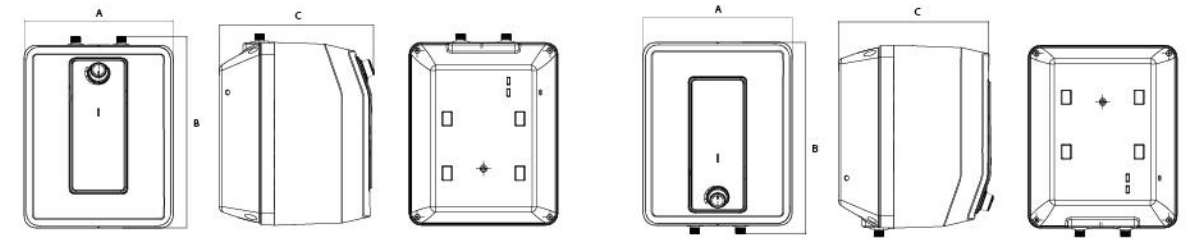

\*Dimensions (mm)

Model	A	B	C
ES15V-Q1(EU)	327	402	333
ES15V-Q2(EU)	327	402	333





**HEAT PUMP**   
WATER HEATER

# Let us prove our advantages

## Wide range

DHW output temperature is from 35°C to 65°C, the working temperature is from -7°C to 45°C, Enjoy happy and safe shower for 365 days.

Working temperature range



DHW output temperature range

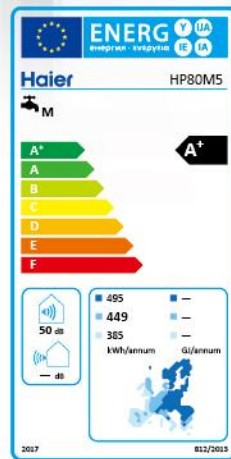

## Energy saving

Haier focus on energy saving and its heat pump achieve the highest level of A+ in EU, also NF performance is 3 stars.

## High efficiency condenser

Full-divisional super conductive condenser with multi flow circuit, it can reduce the flowing resistance and lower the compressor energy consumption to get higher thermal efficiency. The contact area is bigger and fit seamlessly to the tank, which has faster heating speed.

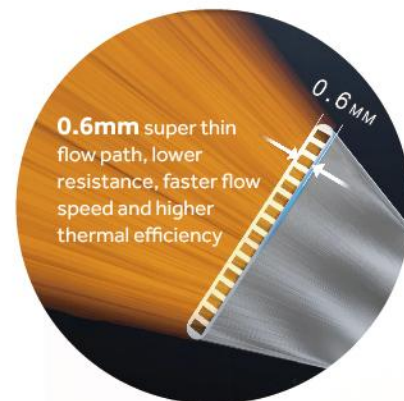

## UMC inner tank

Commercial level UMC tank, exclusive design for water heater, it has longer service life and stable heating performance.

- **Professional quality:** Haier upgraded enamel technology to increase the uniformity and make the high density enamel tank which is resistant to corrosion, acid, alkali and very durable;
- **Advanced formula:** taking use of high quality enamel powder (made in USA) and upgrade the formula to eliminate the pinhole, the granule weight will be lighter and the anti-corrosion performance will be better;
- **Production technology:** the enamel material is melting by super high temperature, the enamel layer will isolate the water and steel plate to prohibit rust and scale. The tank will have longer service life.

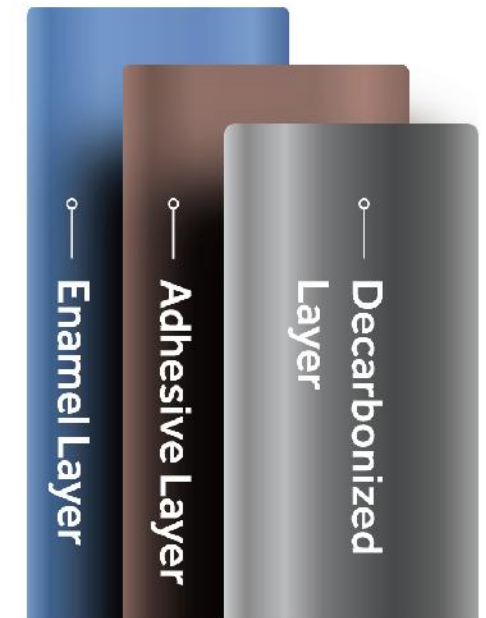

## Easy operation

The user can choose vacation mode which will save cost. The heat pump will not work under vacation mode and it can automatically heat the water to 65°C one day before the vacation ends. This function can sterilize the tank and make sure the user can enjoy healthy water.



## Local subsidy to use heat pump IN SPAIN



HP200S1(EU)

Subsidy:1177.05 Euro  
≈One mobilephone



HP300S1(EU)

Subsidy:1615 Euro  
≈One famous brand watch



HP200M3(EU)

Subsidy:839.025 Euro  
≈One set of TV



HP250M3(EU)

Subsidy:843.975 Euro  
≈One laptop



HP250M3C(EU)

Subsidy:881.1 Euro  
≈One time of vacation cost



HP80M5(EU)

Subsidy:396.25 Euro  
≈One pair of shoes



HP110M5(EU)

Subsidy:398.75 Euro  
≈One famous brand clothing



HP150M5(EU)

Subsidy:447.5 Euro  
≈One ticket of soccer game

Note: The subsidy policy is based on Spanish Royal regulation (477/2021), only for reference, the actual subsidy is subject to local regulations.



## Working principle of Heat pump

### How it works?

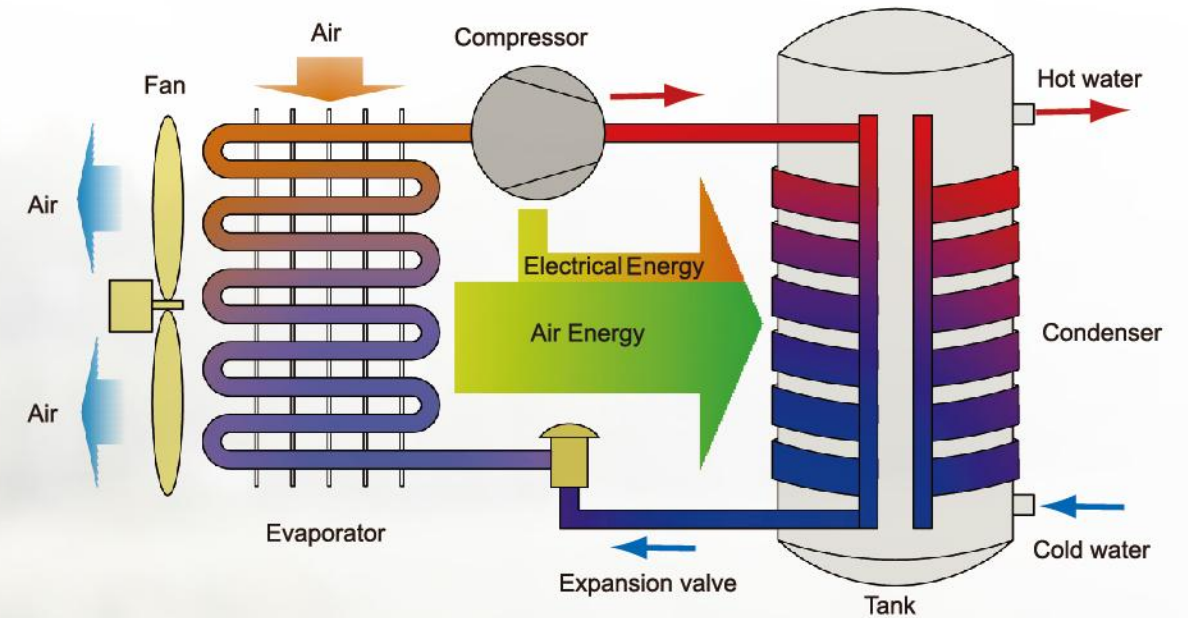

The refrigerant fluid crosses the evaporator and absorbs the heat from the air drawn in by the fan. This process ensures the refrigerant changes state from a liquid to a gas through evaporation

The compressor pressurises the refrigerant gas, which causes it to increase in temperature

The refrigerant fluid loses further pressure and temperature by passing through the expansion valve, causing it to completely return to its original state, it will be working by this recycle

From the condenser, the refrigerant gas transfers its heat to the water, which circulates into the home. This exchange process causes the refrigerant to cool down as it transfers the heat and forces it to return to a partial liquid state

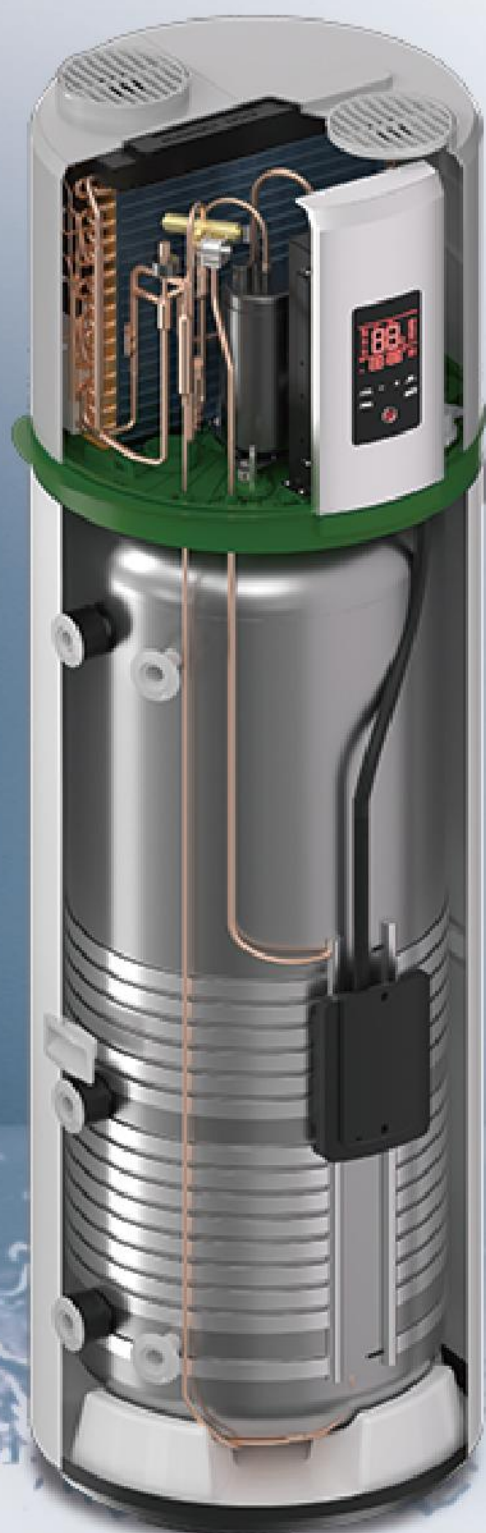

### Smart defrost

Smart defrost system, lower the energy consumption and increase the working efficiency.



### Professional compressor

Specially designed professional heat pump compressor, has service life up to 10 years and very good thermal efficiency.



### Electricity cost saving

Optimized electric control solution, enjoy the low power by PV/HC.



### User-friendly

Big touch screen, easy to operate and real-time display.



### Low noise

Patented ventilation structure and high efficiency fan, make sure the user can enjoy a quiet environment.



### Stable system

Electronic expansion valve control system, more accurate and stable function.



### High class tank

Commercial class 3 layer inner tank, more durable and resistant to acid, alkali and corrosion.



### Higher efficiency

Patented heat convection technology, full-dimensional micro channel and bottom coil heat exchanger to heat the water by whole tank. The thermal efficiency and DHW output will increase dramatically.

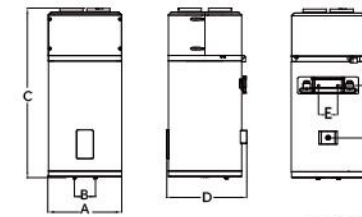

Model	A	B	C	D	E	F
HP80M5(EU)	492	140	1170	537	159	362
HP110M5(EU)	492	140	1320	537	159	362

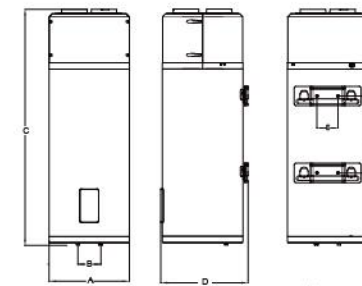

Model	A	B	C	D	E	F
HP150M5(EU)	492	140	1680	537	159	470

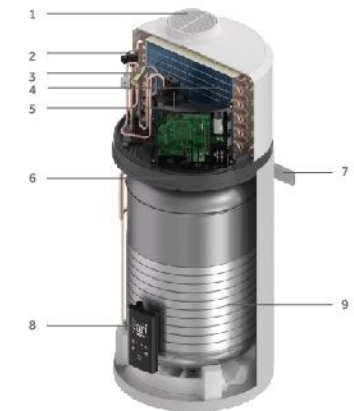
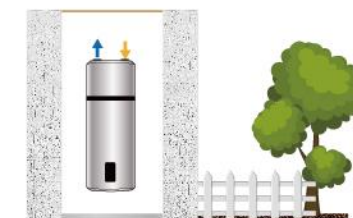
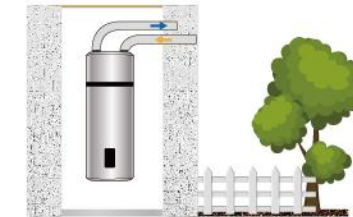

S/N	Description
1	Air grille
2	Electronic expansion valve
3	Four-way-valve
4	Evaporator
5	Compressor
6	Drain pan
7	Support plate
8	Cover for display
9	Micro channel condenser

## HP80M5(EU) HP110M5(EU) HP150M5(EU)



Under Photovoltaic system, you can set the product to optimize use of electricity produced



Easy To Install

Plug and play like electric water heater, easy to install and replace



ECO

Work under low tariff hours to save more electricity cost



Micro-channel Condenser

The micro-channel condenser has larger contact surface for better heat transfer performance



Fast heating

Powerful compressor contribute to shorter heating up time



Slim body

Slim body design saves space



Smart Vacation



Smart Boost



Eco Comfort



ABT



Anti-freeze



Intelligent defrost module

### COMFORT

- Heat pump can heat the water to 65°C
- Heat the water one time by 65°C every 7 days to sterilize legionella
- The noise is only 48.7dB
- 1200W standby power to meet the emergency DHW need

### EFFICIENCY&ENERGY SAVING

- COP is up to 3.58
- A+ energy class
- Smart defrost to increase thermal efficiency
- Working temperature: -7°C-45°C

### QUALITY

- Magnesium anode protection
- Titanium enamel steel tank
- 40 mm PUF insulation

### EASY OPERATION/MULTI-MODE OPTIONS

- Auto mode:** heat pump can supply DHW anytime and electric heating element will auto work over heating time
- ECO mode:** heat pump supply DHW based on set time or electric signal (PV/HC/SG)
- ELEC mode:** only electric heating element is heating water
- Vacation mode:** saving energy by putting unit in a sleep mode under vacation

Model	HP80M5(EU)	HP110M5(EU)	HP150M5(EU)
Installation	Vertical wall-hung/ducted	Vertical wall-hung/ducted	Vertical wall-hung/ducted
Tank volume (L)	82	102	149
Rated voltage/ frequency (V/Hz)	220-240V/50Hz	220-240V/50Hz	220-240V/50Hz
Tank rated pressure (bar)	8	8	8
Extra exchanger design / area	No	No	No
Corrosion protection	Magnesium anode	Magnesium anode	Magnesium anode
Water proof grade	IPX4	IPX4	IPX4
Assembled System			
Electric backup power (W)	1200	1200	1200
Average input - heat pump only(W)	240	240	240
Maximum input- heat pump only(W)	350	350	350
Maximum power input (W)	1550	1550	1550
Default temperature setting (°C)	55	55	55
Temperature setting range with heater (°C)	35-75	35-75	35-75
Temperature setting range heat pump only (°C)	35-65	35-65	35-65
Refrigerant type / Weight (kg)	R134a/0.45	R134a/0.45	R134a/0.46
Ozone Depletion Potential (ODP)	0	0	0
Global Warming Potential (GWP)	1430	1430	1430
Noise power dB(A)	50	50	50
Working temperature - heat pump only (°C)	-7-45°C	-7-45°C	-7-45°C
Working temperature - system (°C)	-7-45°C	-7-45°C	-7-45°C
Performance			
Type of extraction	Exterior	Exterior	Exterior
COP@7°C (EN16147)	2.86	2.74	3.14
COP@14°C (EN16147)	3.17	3.19	3.58
Heating up time (h) (@7°C)	4h58	6h35	10h29
Heating up time (h) (@14°C)	4h09	5h23	8h28
Tapping cycle (EN16147)	M	M	L
Standby power input/ Pes(W) (@7°C)	20	20	21
Maximum volume of usable hot water (L) V40 (EN16147)	109	137	193
Water heating energy efficiency class (ERP)	A+	A+	A+
Dimensions and connections			
Water outlet connection	G1/2" M	G1/2" M	G1/2" M
Water inlet & Drain connection	G1/2" M	G1/2" M	G1/2" M
Safety valve connection	G1/2" M	G1/2" M	G1/2" M
Product Dimensions (D*W*H mm)(tank unit/external unit)	492*537*1170	492*537*1320	492*537*1680
Packing dimensions(D*W*H mm)(tank unit/external unit)	587*587*1247	587*587*1397	587*587*1764
Gross weight (kg)	59	64	89
Net weight(kg)	51	55	67
Load qty.40HQ	160	80	80





## HP200M3(EU) HP250M3(EU) HP250M3C(EU)



Under Photovoltaic system, you can set the product to optimize use of electricity produced



You can choose the heat pump to heat water under off-peak period to save cost



Micro channel and bottom coil heat exchanger with bigger contact surface to heat the water by whole tank. The thermal efficiency will increase dramatically



Powerful compressor contribute to shorter heating up time



HP 250M 3C have a coil exchanger, can be connected with solar water heaters or gas boiler as backup power to maximum the energy saving



### HIGH EFFICIENCY/ECONOMY

- ◆ A+ Energy Class
- ◆ COP is up to 3.56
- ◆ Multiple Energy Source Capability (HP250M3C only)
- ◆ High Performance Compressor
- ◆ Micro-Channel Condenser
- ◆ 50mm PUF Insulation
- ◆ -7°C-45°C wide working temperature range

### EASY OPERATION/MULTI-MODE OPTIONS

- ◆ **Auto mode:** heat pump can supply DHW anytime and electric heating element will auto work over heating time
- ◆ **ECO mode:** heat pump supply DHW based on set time or electric signal (PV/HC)
- ◆ **Vacation mode:** saving energy by putting unit in a sleep mode on vacation

### EASY INSTALLATION

As a monoblock heat pump water heater, it can be easily installed to replace a traditional electric storage water heater with requiring gas connection. Compared with the split heat pump water heater, a monoblock is more flexible on choosing installation locations and saving installation cost! When installed in locations such as unfinished basement, a monoblock provides cooling

### HEALTHY

For every 7 days, the ABT feature will raise tank water temperature to 65°C, to sanitize inner tank by killing 99% bacteria. Enjoy clean and healthy shower water with this automatic anti-bacteria technology

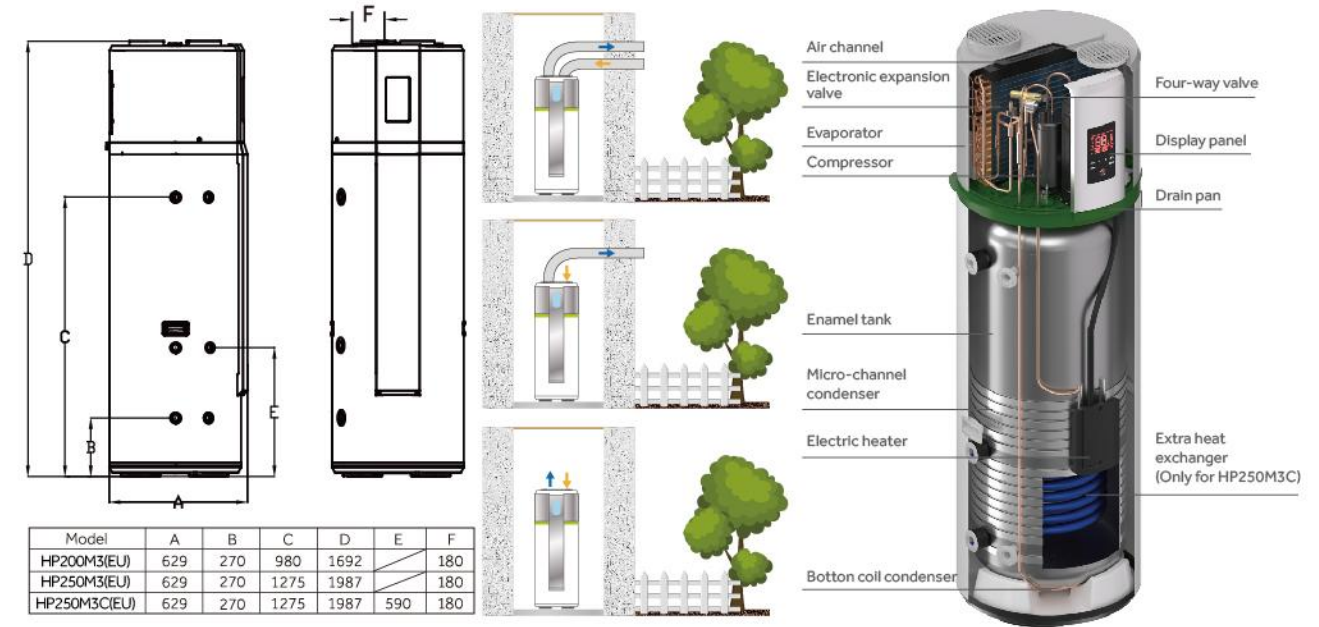

Model	A	B	C	D	E	F
HP200M3(EU)	629	270	980	1692		180
HP250M3(EU)	629	270	1275	1987		180
HP250M3C(EU)	629	270	1275	1987	590	180

Model	HP200M3(EU)	HP250M3(EU)	HP250M3C(EU)
Tank volume (L)	195	246	240
Rated voltage/ frequency (V/Hz)	230V/50Hz	230V/50Hz	230V/50Hz
Tank rated pressure (bar)	7	7	7
Extra exchanger design / area	No	No	1m <sup>2</sup>
Corrosion proof	Magnesium anode	Magnesium anode	Magnesium anode
Assembled System			
Electric backup power (W)	1500	1500	1500
Average input - heat pump only(W)	495	495	495
Maximum input- heat pump only(W)	865	865	865
Maximum power input (W)	2365	2365	2365
Default temperature setting (°C)	55	55	55
Temperature setting range with heater (°C)	35-75	35-75	35-75
Temperature setting range heat pump only (°C)	35-65	35-65	35-65
Refrigerant type / Weight (kg)	R134a/0.9	R134a/0.9	R134a/0.9
Noise power db(A)	57	58	59
Working temperature - system (°C)	-7-45	-7-45	-7-45
Performance			
Type of extraction	Ambient / Exterior	Ambient / Exterior	Ambient / Exterior
COP@7 °C (EN16147)	3.04	3.02	3.1
COP@15 °C (EN16147)	3.39	3.41	3.56
Tapping cycle (EN16147)	L	L	L
Standby power input/ Pes(W)	27	27	27
Vmax	224	311	332
Heating up time (h) (@7°C)	5h30	7h21	6h55
Heating up time (h) (@15°C)	4h41	6h10	6h
Dimensions and connections			
Product Dimensions (D*W*H mm)-Tank	600*629*1692	600*629*1987	600*629*1987
Packing dimensions (D*W*H mm)-Tank	736*695*1940	736*695*2250	736*695*2250
Gross weight (kg)-Tank/external unit	103	116	132
Net weight (kg)-Tank/external unit	91	102	119
Load qty.40HQ	51	51	51

## Connection to solar collectors(HP250M3C(EU))

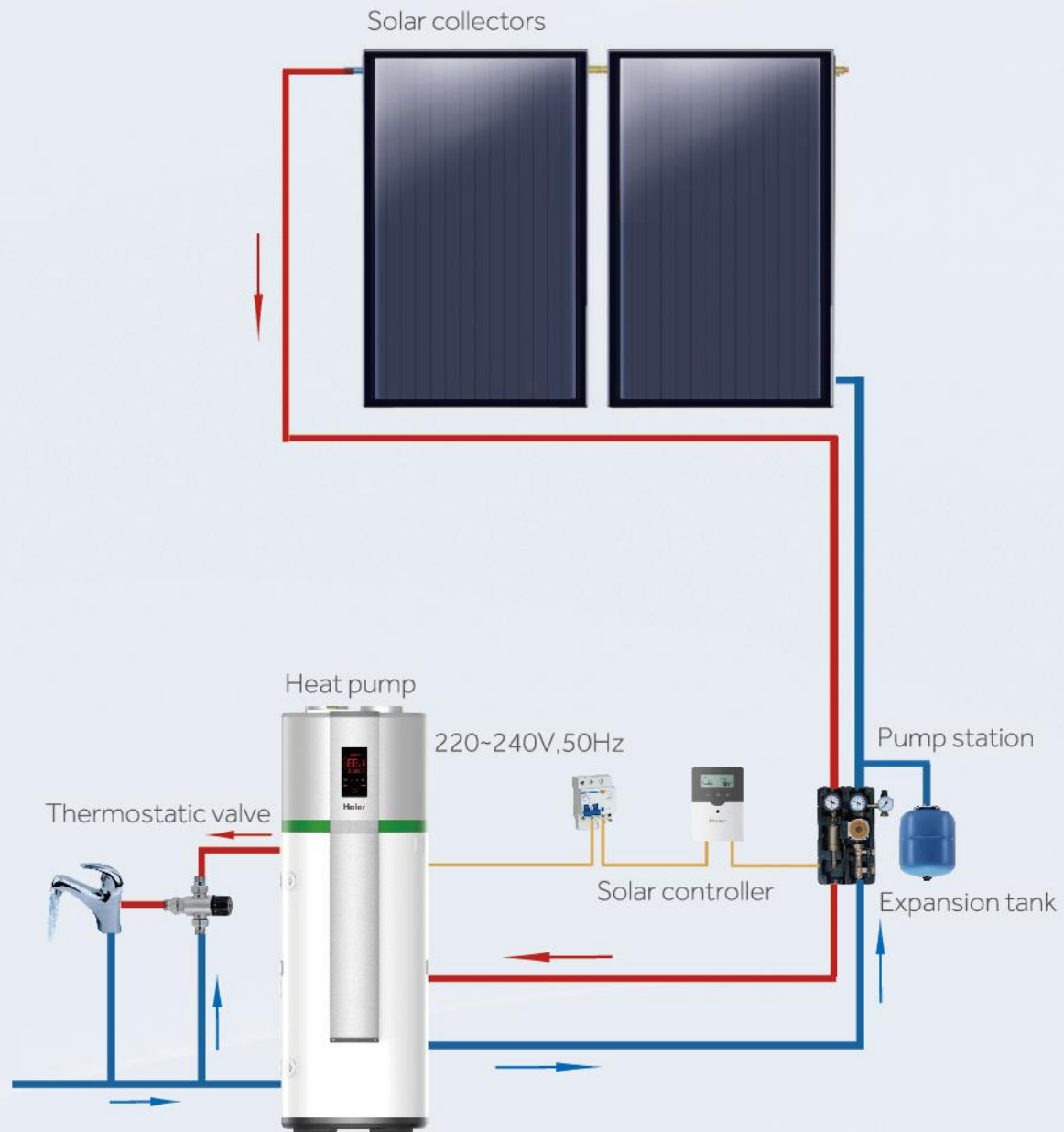

## Connection to gas boiler(HP250M3C(EU))

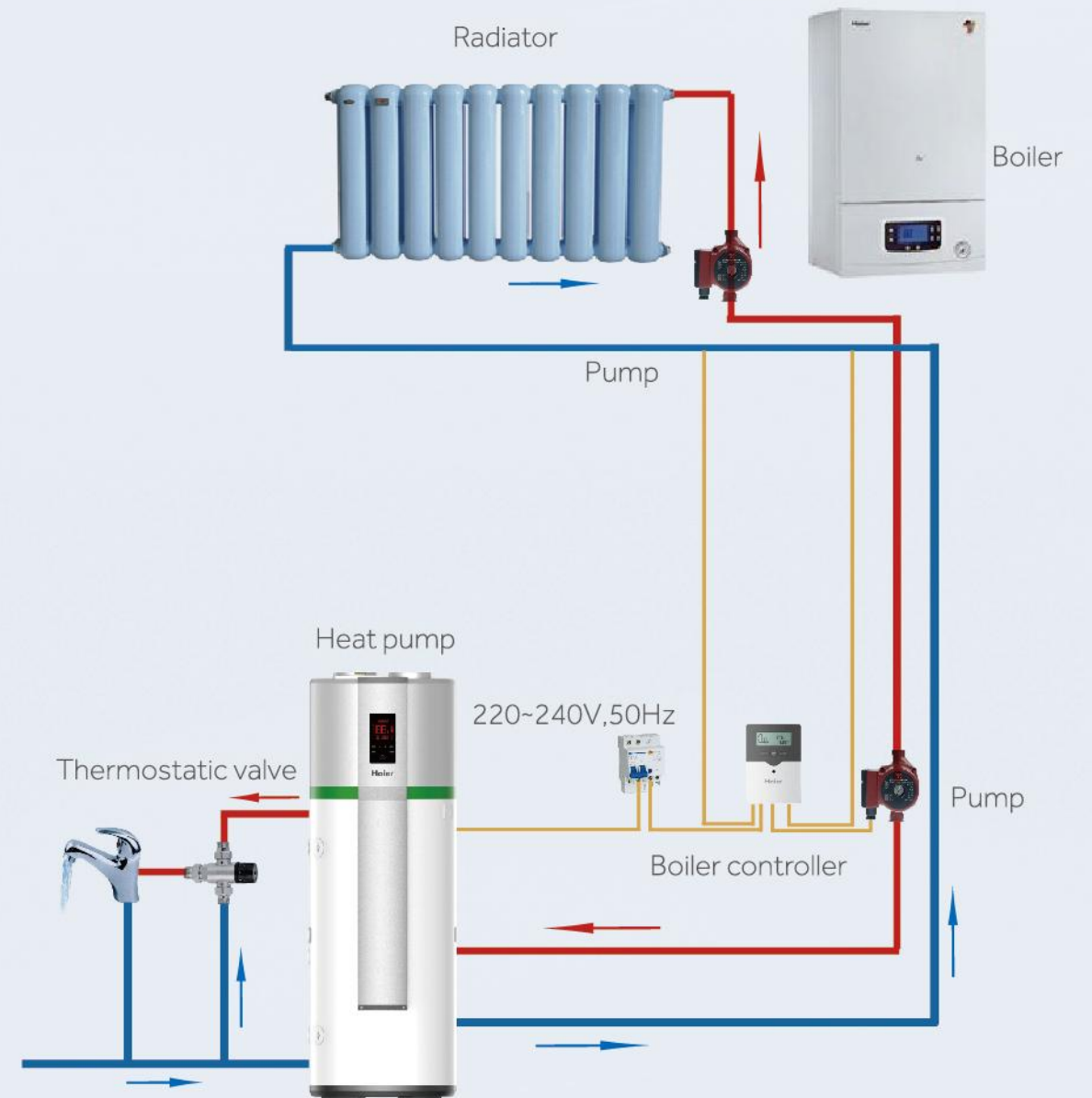



Model	a1	b1	c1	d1
HP200S1(EU)	1765	512	522	1270
HP300S1(EU)	1795	600	610	1242

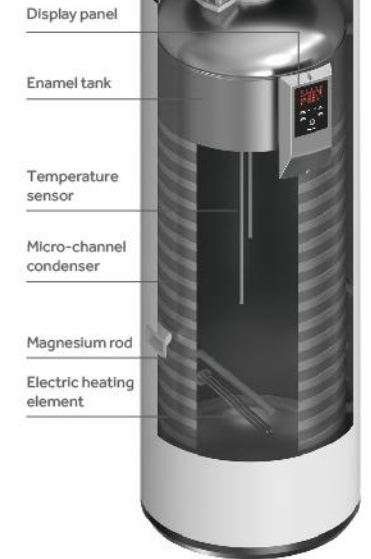
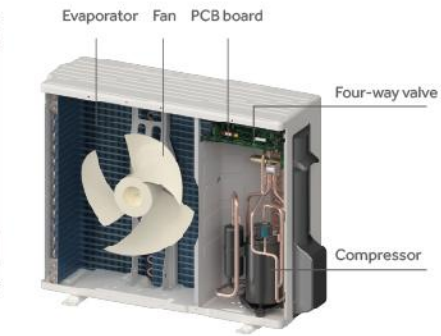
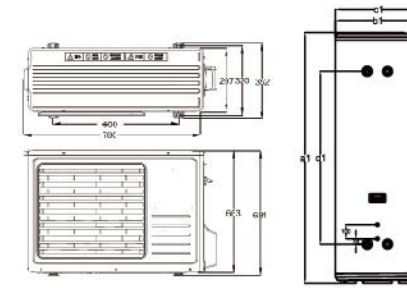

## HP200S1(EU) HP300S1(EU)



Micro-channel Condenser

Micro channel and bottom coil heat exchanger with bigger contact surface to heat the water by whole tank. The thermal efficiency will increase dramatically



Fast heating

Powerful compressor contribute to shorter heating up time



Eco Comfort

Under Eco mode, water is heated by heat pump exclusively to maximize efficiency and economy



Intelligent defrost module

Monitors the operating temperature through multi-touch sensors and performs intelligent defrost on demand to prevents invalid operation. It is more effective and energy-saving than scheduled defrost



Quiet Operation



High Efficiency



Anti-freeze



Auto Defrost



ABT



Vacation Mode



Smart Boost

### HIGH EFFICIENCY/ECONOMY

- ◆ A+ Energy Class
- ◆ COP is up to 3.8
- ◆ High Performance Compressor
- ◆ Micro-Channel Condenser
- ◆ 50mm PUF Insulation
- ◆ -7°C-45°C wide working temperature range

### EASY OPERATION/MULTI-MODE OPTIONS

- ◆ **Auto mode:** heat pump can supply DHW anytime and electric heating element will auto work over heating time
- ◆ **ECO mode:** heat pump supply DHW all the time, the electric heating element only is working in off-peak period
- ◆ **ECO+ mode:** heat pump only supply DHW in off-peak period and electric heating element is working in off-peak period
- ◆ **Vacation mode:** saving energy by putting unit in a sleep mode on vacation

### MORE HOT WATER

- ◆ 200L & 300L Capacity
- ◆ Maximum Volume of Usable Hot Water (L) V40 (EN16147) is Up to 382L (HP300S1).
- ◆ Maximum Water Temperature with Heat Pump Only is Up to 65°C

### QUICK HEATING

- ◆ Under boost mode, heat pump and electric heating element (2150W power) will work together to supply DHW quickly
- ◆ Heating 300L of water only takes 4h45min (@7°C)

Model	HP200S1(EU)	HP300S1(EU)
Model (tank unit)	TS200HE-S1	TS300HE-S1
Model (external unit)	UE1.0-S1	UE1.5-S1
Tank volume (L)	195	293
Rated voltage/ frequency (V/Hz)	230V/50Hz	230V/50Hz
Tank rated pressure (bar)	8.5	8.5
Extra exchanger design / area	No	No
Corrosion protection	Magnesium anode	Magnesium anode
Water proof grade	IPX4	IPX4
Assembled System		
Electric backup power (W)	2150	2150
Average input - heat pump only(W)	665	850
Maximum input- heat pump only(W)	1000	1350
Maximum power input (W)	3150	3500
Default temperature setting (°C)	55	55
Temperature setting range with heater (°C)	35-75	35-75
Temperature setting range heat pump only (°C)	35-65	35-65
Refrigerant type / Weight (kg)	R134a/1.3	R134a/1.5
Ozone Depletion Potential (ODP)	0	0
Global Warming Potential (GWP)	1430	1430
Noise power dB(A)	64	64
Working temperature - heat pump only (°C)	-7-45°C	-7-45°C
Working temperature - system (°C)	-7-45°C	-7-45°C
Performance		
Type of extraction	Exterior	Exterior
COP@7°C (EN16147)	3.09	3.2
COP@14°C (EN16147)	3.54	3.8
Heating up time (h) (@7°C)	4h03	4h45
Heating up time (h) (@14°C)	3h32	3h49
Tapling cycle (EN16147)	L	XL
Standby power input/ Pcs(W) (@7°C)	28	29
Maximum volume of usable hot water (L) V40 (EN16147)	245.1	382.6
Water heating energy efficiency class (ERP)	A+	A+
Dimensions and connections		
Water outlet connection	G3/4" F	G3/4" F
Water inlet & Drain connection	G3/4" F	G3/4" F
Safety valve connection	G3/4" F	G3/4" F
Product Dimensions (D*W*H mm)(tank unit/external unit)	544*512*1765/899*352*681	632*600*1795/899*352*681
Packing dimensions(D*W*H mm)(tank unit/external unit)	676*636*1927/960*425*735	737*696*1958/960*425*735
Gross weight (kg)	89/44	112/48
Net weight (kg)	77/41	98/44
Load qty.40HQ	59	51





Model		HP80M5(EU)	HP110M5(EU)	HP150M5(EU)	HP200M3(EU)	HP250M3(EU)	HP250M3C(EU)	HP200S1(EU)	HP300S1(EU)
<b>Comfortable</b>	Electric Heating Element	√	√	√	√	√	√	√	√
	Boost Heating Mode	√	√	√	√	√	√	√	√
	LED Touch Control	√	√	√	√	√	√	√	√
	Centrifugal Fan	√	√	√	√	√	√		
	Connectable wind pipes	√	√	√	√	√	√		
	Extra exchanger design						√		
<b>Healthy</b>	65°C Tank Sterilization	√	√	√	√	√	√	√	√
<b>Reliable</b>	Professional Compressor	√	√	√	√	√	√	√	√
	Incoloy Heating Element	√	√	√	√	√	√	√	√
	Enamel tank	√	√	√	√	√	√	√	√
<b>Safe</b>	Patented Shock Proof	√	√	√					
<b>Efficient</b>	Patented Micro Channel Condenser	√	√	√	√	√	√	√	√
<b>Smart</b>	Auto Defrost	√	√	√	√	√	√	√	√
	PV	√	√	√	√	√	√		
	Peak Valley Electricity Detect	√	√	√	√	√	√	√	√
	Vacation mode	√	√	√	√	√	√	√	√

# Haier heat pump solutions for overseas market

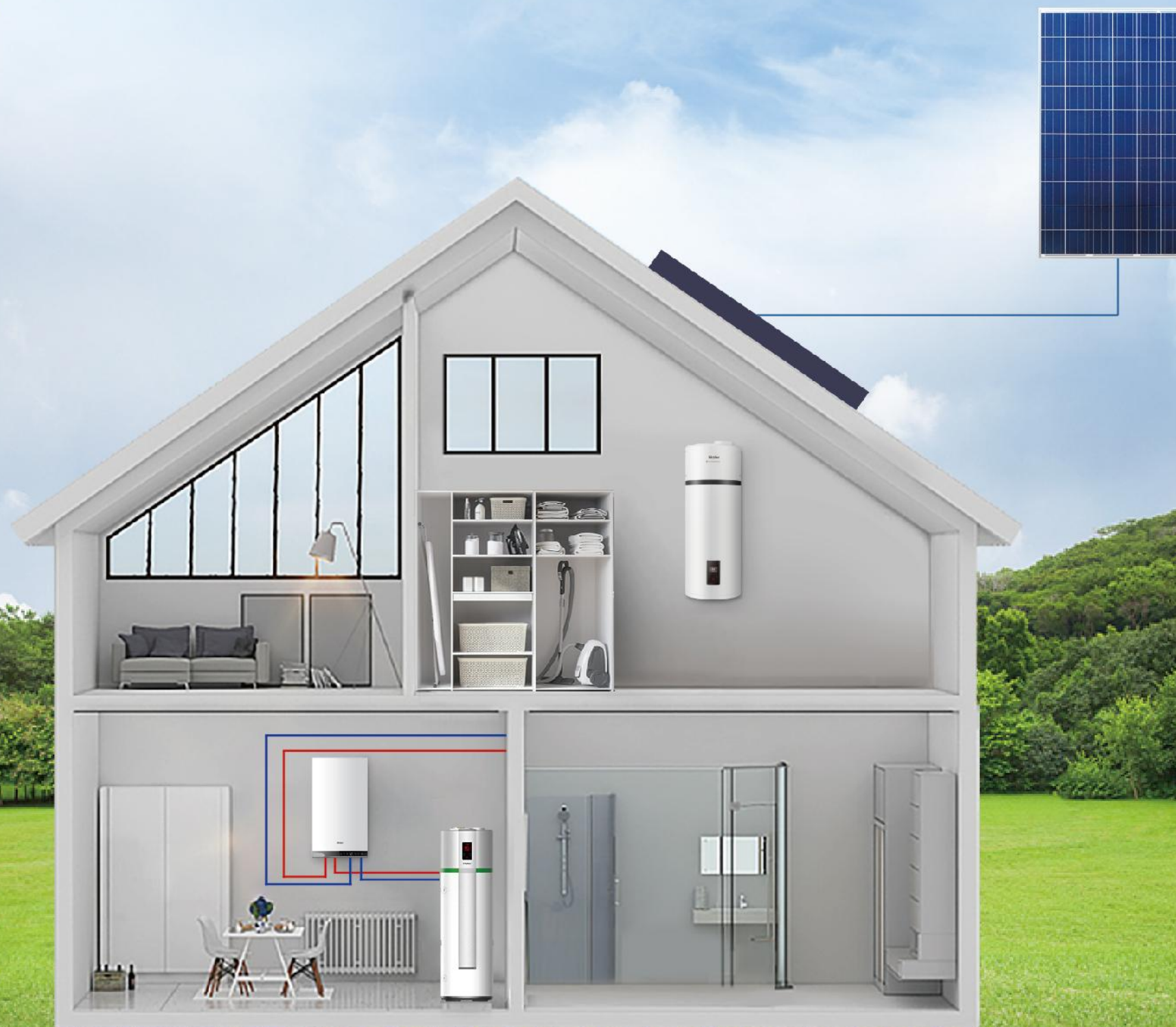

Heat pump+PV system scenario Product series: M3/M5  
Heat pump+Gas boiler scenario Product series: M3C



# Installation Guidelines

## M5 series installation guideline-Wind pipe



- 1 Air duct  $\varnothing$  160 mm
- 2 90° elbow
- 3 Duct connector - (set of 2)
- 4 Strainer  $\varnothing$  160 mm

## M5 series installation guideline-Bracket

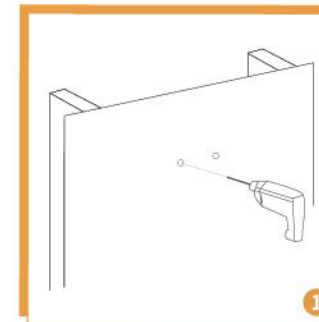
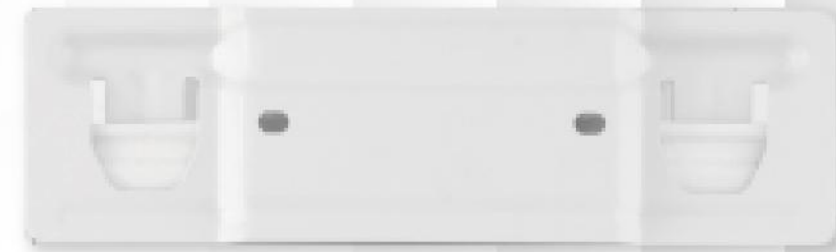

Select the installation wall (the load-bearing wall can bear at least 200KG), and drill two expansion screw holes on the wall, the distance between the expansion screw holes is 159mm.

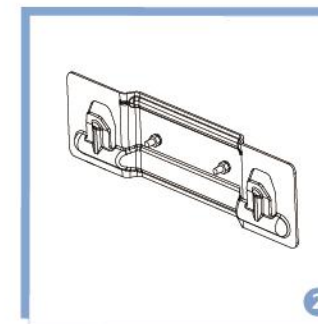

Align the expansion screws with the mounting holes on the wall plate, tighten the expansion bolts and nuts, and the wall plate is installed.



Lift the heat pump by two persons.

## M3 series installation guideline



- 1 Air duct Ø 180 mm
- 2 90° elbow
- 3 Duct connector - (set of 2)
- 4 Strainer Ø 180 mm

## S1 series installation guideline-Refrigerant tube

- 1 Shape the pipes according to the path;
- 2 Remove the threaded brass flare nuts(A) on the tank unit and store them (check that no impurities are left);
- 3 Cut the pipe to the fixed length, with a pipe cutter, avoiding any deformation;
- 4 Remove burrs with pipe reamer avoiding to get impurities inside (keep down the tube);
- 5 Insert the threaded brass flare nuts(A) on the pipes in the correct direction;
- 6 Insert the tube into the flaring tool and make the flange at the end of the connecting pipe, as indicated in the table.

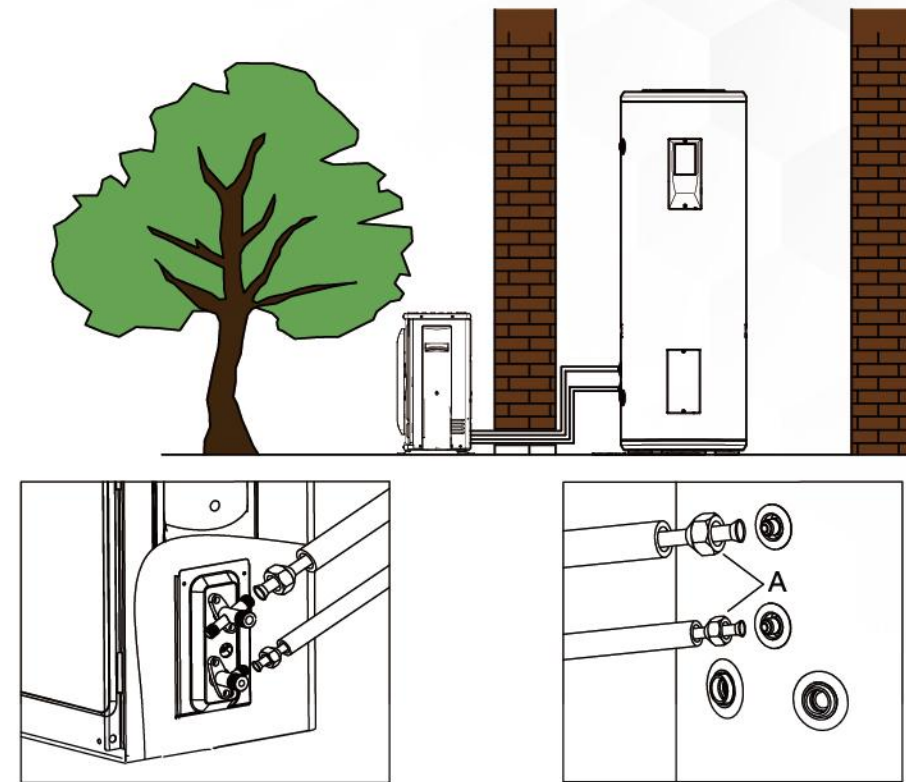

## Installation specification

Tubo(non fornita)	Specificazione	Spessore	Coppia di serraggio [Nm]
Tubo del refrigerante in ingresso	φ6.35 mm (1/4")	0.8mm	15-20
Tubo refrigerante di uscita	φ9.5 mm (3/8")	0.8mm	29-34