

**Haier**  
Inspired Living

**A+**  
Energy Class



## NEW SOLUTIONS FOR ECO & EFFICIENT HOT WATER

Haier EIP+ Series Air Source Heat Pump Water Heater

# BRING ECOLOGY & EFFICIENCY TO A NEW LEVEL



Heat pumps utilize free and renewable energy from the outside air, resulting in cost savings for users while also reducing the environmental impact of carbon emissions. Compared to conventional electric storage water heaters, heat pumps can save up to 80% of energy for domestic hot water in households. This makes them suitable for both new build and renovated homes.

# ***GREEN FOR YOU AND THE EARTH***

---

The new natural refrigerant, R290, is an environmentally friendly choice that reduces carbon emissions and contributes to the global goal of carbon neutrality.





# ECO - R290

## NATURAL REFRIGERANT

### New R290 Refrigerant, More Eco-friendly

In order to achieve carbon neutrality and mitigate global warming, the Haier EIP+ series air source heat pump water heater uses R290 natural refrigerant, which is a trend of advanced household water solutions, to offer sustainable, green, and comfortable hot water solutions.



### Natural, Non-toxic, and Free of Ozone Depletion

The R290 is a high-purity propane refrigerant with a global warming potential (GWP) of 3. This indicates that it will contribute less to ozone depletion compared to other alternatives.





## ECO - R290

# NATURAL REFRIGERANT

### Excellent Thermodynamic Performance

The R290 refrigerant offers excellent thermodynamic performance, allowing for higher water temperatures to meet various application demands.

#### Up to 65°C Water Temperature

The heat pump works alone to make the water temperature as high as 65 °C, and the water mixing rate at 40 °C can reach 125%, which is equivalent to 25% capacity increase, saving power and enjoying surging water.



### Higher Water Temperatures for Shower and Bacterial Proof

✓ For Shower



✓ For Bacterial Proof

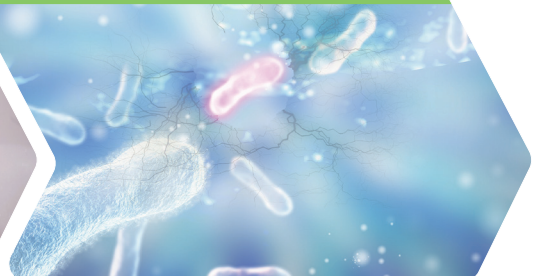



## ***HIGH-EFFICIENCY AND ENERGY SAVING***

The technologically advanced Haier EIP+ series air source heat pump water heater features full inverter technology and micro-channel condenser, resulting in lower energy consumption and higher heating efficiency.



# EFFICIENCY

## 80% ENERGY SAVING

### Absolute Efficiency, A+ ErP Energy Rating

Haier EIP+ series air source heat pump water heater achieves A+ energy rating, as illustrated in the product label.

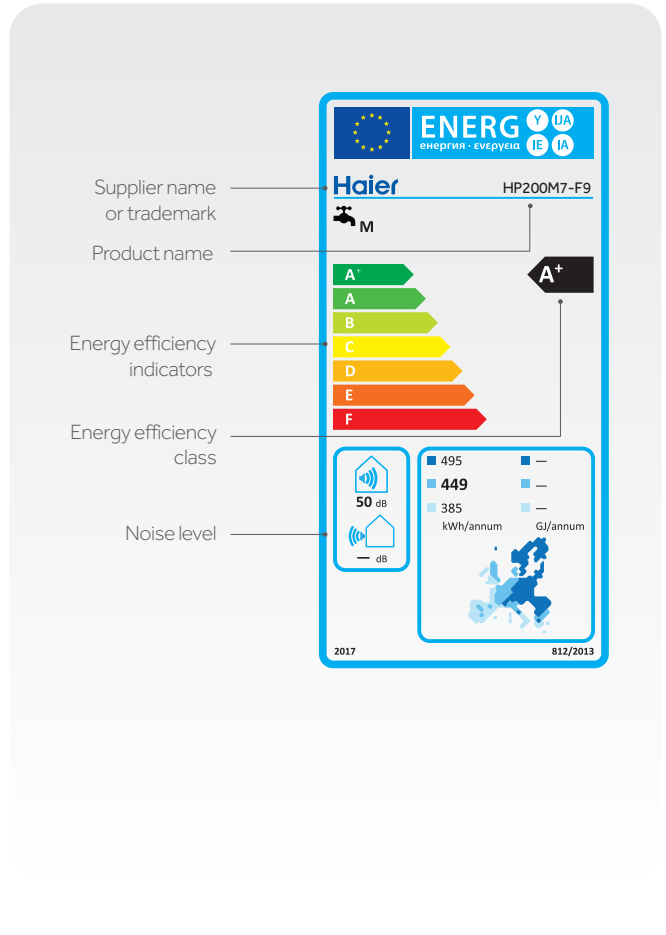

### COP3.6\*, 80% Energy Saving

High efficiency means low energy costs, the Haier EIP+ series air source heat pump water heater can greatly reduce energy bills for users.

\*Tested at 14°C operating conditions





# EFFICIENCY

## 80% ENERGY SAVING

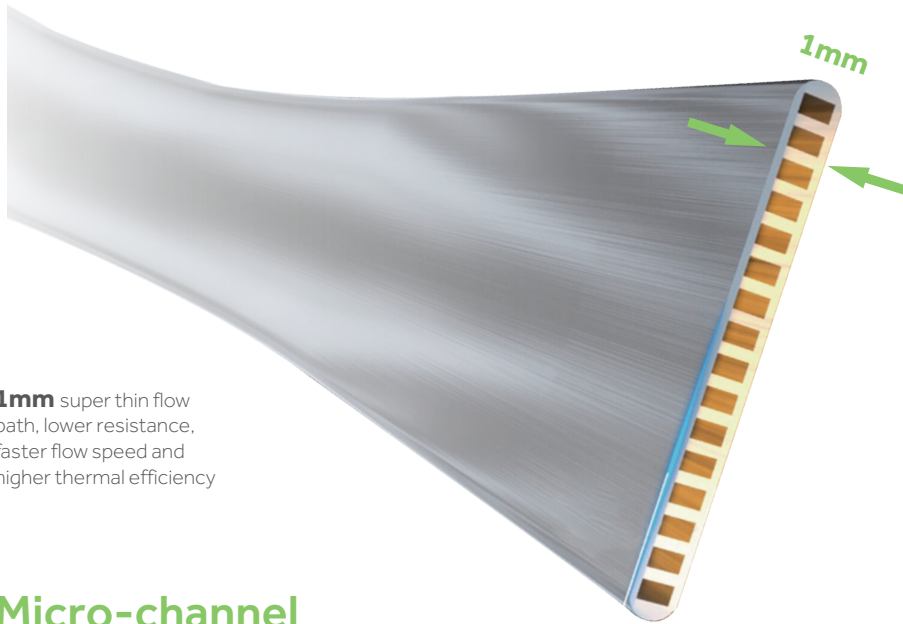

**1mm** super thin flow path, lower resistance, faster flow speed and higher thermal efficiency

### Micro-channel Upgraded for R290 Refrigerant

The surface contact heat exchange area is larger, and the refrigerant is fully fed and heat is exchanged in a very small flow path, which greatly improves the efficiency of heat exchange compared to traditional heat exchangers.



Improve performance



Increase heat transfer efficiency



Reduce power consumption

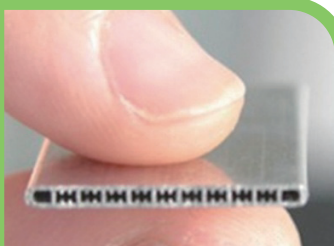

Multi-path design with multiple ultra-fine micro-channels in each path, enabling more efficient heat transfer while reducing flow resistance and lowering power consumption, resulting in a performance improvement.



The larger heat transfer surface area leads to an increase in heat transfer efficiency.

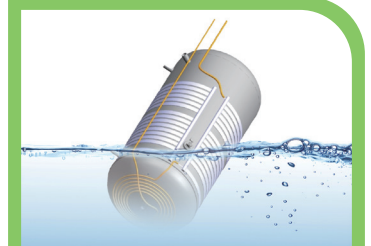

Uniform heating with temperature differences of within 4°C between the upper and lower layers, minimal stratification of hot water, outperforming copper pipe heat exchangers, and effectively reducing power consumption.





# EFFICIENCY

## 80% ENERGY SAVING

### Full Inverter Technology, Energy-Saving with Continuously Variable

The high-quality inverter compressor and DC fan, combined with integrated inverter drive module, significantly improve electrical energy utilization. The system dynamically adjusts input power based on unit operation, ensuring optimal energy efficiency at all times. It maintains stability even in low-temperature conditions and achieves even greater energy saving during high-temperature conditions.

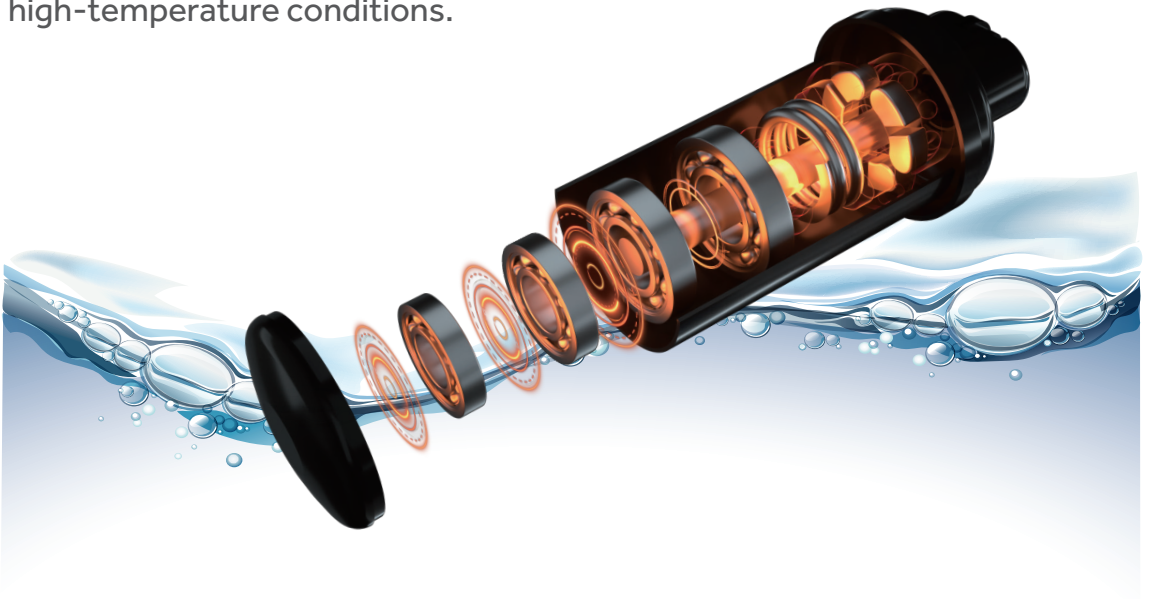

#### Inverter Compressor



Adjusting input power based on the machine's operational status to achieve high energy efficiency.

#### DC Fan



Under the same air volume, the power of the DC fan is 40% to 50% lower than AC fan, making the system more energy-efficient.



## EFFICIENCY

# 80% ENERGY SAVING

### Dual Power Heating, Enables Faster Hot Water Production

The dual power heating mode of air energy and electric energy is adopted, and electric heating (1500W electric auxiliary) can be started at the same time to improve the heating efficiency in case of low temperature in winter/urgent need of a large amount of hot water, so as to achieve fast heating of the whole tank of water in a short time and obtain a large amount of hot water.





### Hot Water is Available in Less Time





In the cold winter, the compressor increases input power to stabilize heat production.





When a large amount of hot water is urgently needed, dual power is more efficient.



# EFFICIENCY

## 80% ENERGY SAVING

### Smart Defrost, More Efficient and Energy Saving

Haier smart defrosting control system is equipped with a four-way valve and an electronic expansion valve with higher refrigerant flow control accuracy, the defrosting effect is more sufficient, so that it is not easy to frost in low temperature conditions.

Monitor Determine Defrost

**Haier**

When tested at 7/6°C, the evaporator's frosting condition.

**OTHERS**

When tested at 7/6°C, the evaporator's frosting condition.



## ***EXCELLENT PERFORMANCE YEAR AFTER YEAR***

Better heating, better reliability. The R290 dedicated compressor and high-quality enamel tank offer a longer service life and stable heating performance.



# HIGH QUALITY AND DURABLE

## R290 Dedicated Compressor, High-quality and Efficient

Optimized internal structure of the compressor effectively reduces refrigerant storage inside the compressor, enhancing the refrigerant circulation in the system.



### High Efficiency/Economy

- By using an efficient new pump structure, efficiency increases by more than 2%.
- Based on the characteristics of R290, dedicated refrigeration compressor oil enhances system efficiency, even in situations with low charge levels.



### Low Noise Operation

Optimize motor airflow channel and compressor noise reduction structure, result in a 2.5~3dB(A) decrease in compressor noise level.



# HIGH QUALITY AND DURABLE

## High-quality Enamel Tank, Longer Service Time

High-quality enamel tank, featuring an exclusive design for water heaters, offers a longer service life and stable heating performance.



### Professional Quality

Haier has upgraded its enamel technology to enhance uniformity and create a high-density enamel tank that is resistant to corrosion, acid, alkali, and extremely durable.

### Advanced Formula

By using high-quality enamel powder (made in the USA) and upgrading the formula to eliminate the pinhole, the granule weight will be lighter and the anti-corrosion performance will be better.

### Production Technology

The enamel material is melted at super high temperature, the enamel layer will isolate the water and steel plate to prevent rust and scale. The tank will have longer service life.

# ***POWER YOUR HOME THE SMART WAY SAVE ENERGY BILLS***

With its advanced capabilities, the multi-energy connected feature allows users to choose economical electrical energy, helping them save energy and reduce costs.

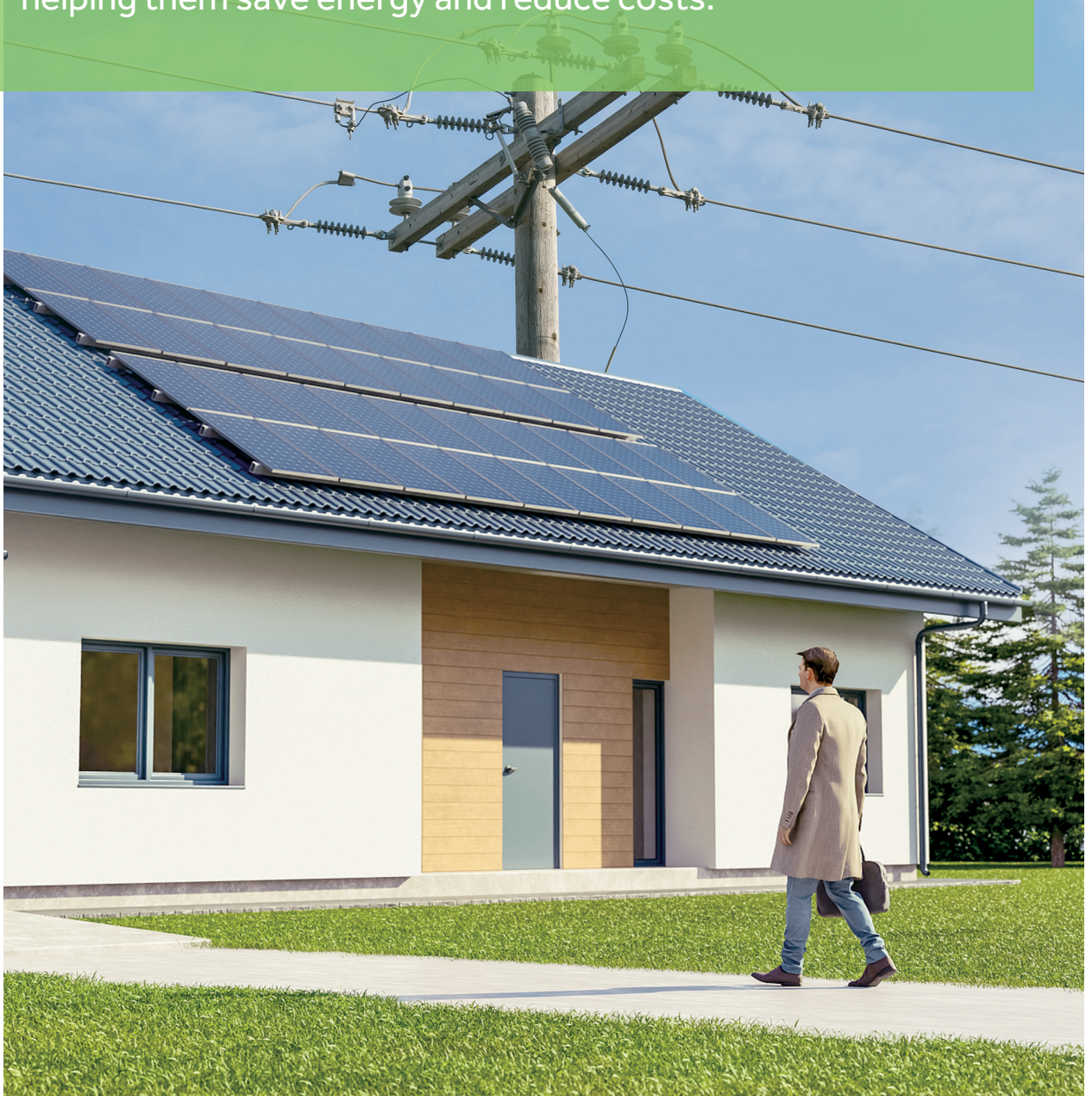



# ECONOMICAL MULTI-ENERGY CONNECTED

## Choose Economical Electrical Energy

Power signal	If you need to meet water usage priority	If you need to balance between water usage and economic benefit	If you need maximum economic benefit
<b>PV</b>	<p><b>Electric signal</b></p> <p>E1-Heat pump and electric heating meanwhile when there is sufficient PV F1-Activate and heat immediately, no signal returns to the current mode</p> <p><b>MODE</b></p> <p>AUTO</p>	<p><b>Electric signal</b></p> <p>E1-Heat pump and electric heating meanwhile when there is sufficient PV F3-Activate and heat immediately, mode is disabled. Keep the water temperature at 40°C without signal</p>	<p><b>Electric signal</b></p> <p>E1-Heat pump and electric heating meanwhile when there is sufficient PV F4-Activate and heat immediately, No heating when there is no signal. (Former set mode is disabled.)</p>
<b>Off-peak</b>	<p>If there are intermittent signals from the power company</p> <p><b>Electric signal</b></p> <p>E1-Heat pump and electric heating meanwhile F2-Only activate and heat in the heating time of the current mode</p> <p><b>MODE</b></p> <p>AUTO</p> <hr/> <p>If it is during a fixed time period with off-peak electricity</p> <p><b>MODE</b></p> <p>ECO</p>	<p>If there are intermittent signals from the power company</p> <p><b>Electric signal</b></p> <p>E2-Heat pump (electric heating is only started after the water temperature is 65°C) F3-Activate and heat immediately, mode is disabled. Keep the water temperature at 40°C without signal</p> <hr/> <p>If it is during a fixed time period with off-peak electricity</p> <p><b>MODE</b></p> <p>ECO</p>	<p>If there are intermittent signals from the power company</p> <p><b>Electric signal</b></p> <p>E2-Heat pump (electric heating is only started after the water temperature is 65°C) F4-Activate and heat immediately, No heating when there is no signal. (Former set mode is disabled.)</p> <hr/> <p>If it is during a fixed time period with off-peak electricity</p> <p><b>MODE</b></p> <p>ECO</p>

\*The mode can be set according to the power situation in your home, for reference only.





# ECONOMICAL MULTI-ENERGY CONNECTED

## Multi-energy Connected

Combine with boiler, solar thermal, PV, save energy and reduce costs.



- **Solar Water Heater & Heat Pump Water Heater**

Priority given to solar energy, greatly reduce energy bills for users.

- **Gas Boiler & Heat Pump Water Heater**

As a compensatory energy source for heat pumps to achieve higher water temperatures.



- **PV & Heat Pump Water Heater**

Select PV power to save electricity cost.



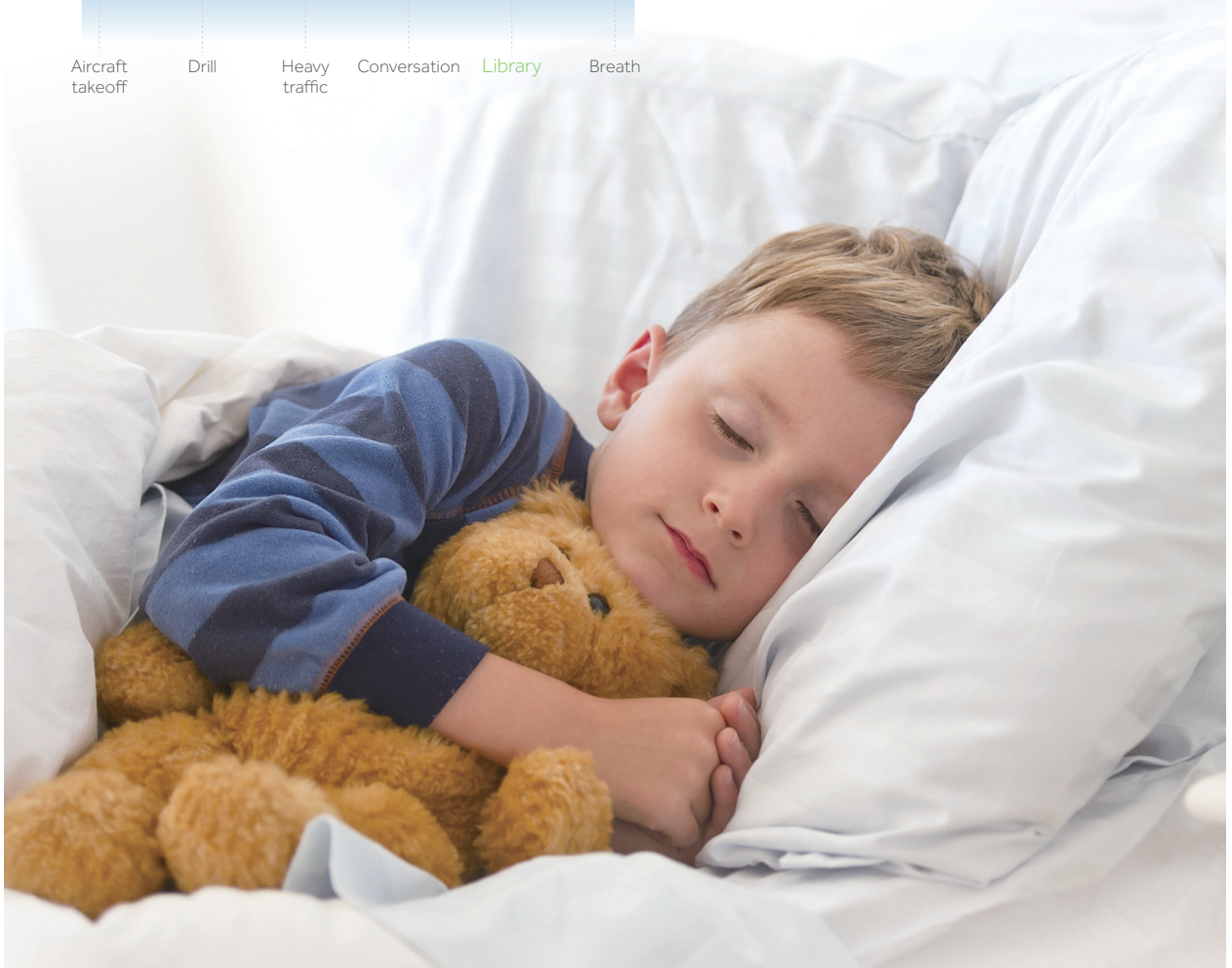
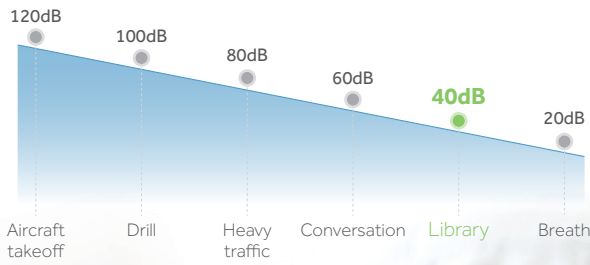

## ***A QUIET HOME, A COMFORTABLE LIFE***

Haier advanced features, including a full inverter system, a soundproof enclosure design, and a dedicated mute mode, guarantee whisper-quiet operation without compromising performance.



# COMFORTABLE LOW NOISE

Operating at 40dB,  
as Quiet as a Library



## SilentPlus Quiet Operation (Below 40dB)

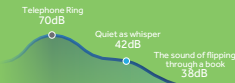

## Full Inverter System

Inverter compressor and DC fan ensure smooth and low noise operation.



## Soundproof Enclosure Design

Effectively isolates the operating noise of the compressor.

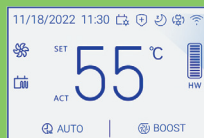

## Mute Mode

Set the time for mute operation, operate quietly during the night.

# ***A NEW DEFINITION OF COMFORT CONTROL***

Home gets smarter, life gets simpler. Equipped with a TFT screen and smart connectivity, the Haier EIP+ series air source heat pump water heater offers superior comfort in an efficient and intuitive manner. Experience the joy of a smart life.





# SMART & CONVENIENT

## Connect and Control from Anywhere, Anytime

Haier EIP+ series air source heat pump water heater can be operated from your mobile devices via WiFi. With the hOn app, you can easily control the heat pump anytime from anywhere.



## hOn App: Your Smart Life Companion

Your appliance can be connected to your home wireless network and operated remotely using the app.

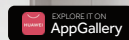
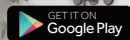

### Getting started

- 1 Ensure that your home WiFi network is turned on.
- 2 After startup, it will enter fast pairing mode without the need for manual operation.
- 3 If the connection is successful, the WiFi icon (📶) will always be on.

### On your mobile device

- 1 Download the app from <https://hon-smarthome.com/>.
- 2 Register and create an account.
- 3 Add your appliance and set up the WiFi connection.



# SMART & CONVENIENT

## Large Screen Display

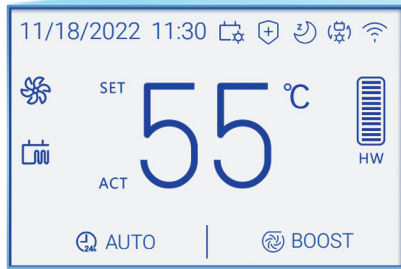

## Meet Various Water Usage Needs



### AUTO Mode

Automatically heat water to set temperature and maintain it.



### ECO Mode

In this mode, priority of heat pump heating; User entered timer settings.



### ELEC Mode

In this mode, the backup element is used as the only heat source. This function ensures hot water supply when the heat pump is not working properly.



### BOOST Mode

Heat pump and backup element are activated at the same time.



### VAC Mode

Maintains a minimum temperature to prevent freezing.





# SMART & CONVENIENT

## Intuitive Operational Information



### Information

Query the electric energy consumption information of the unit.

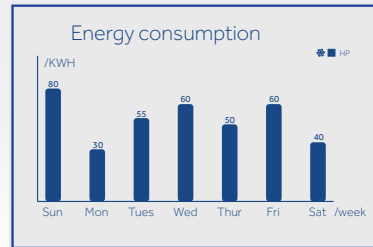
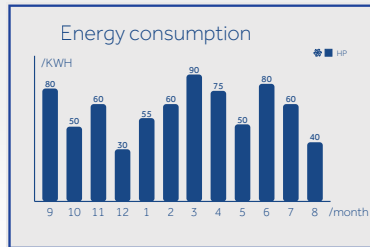
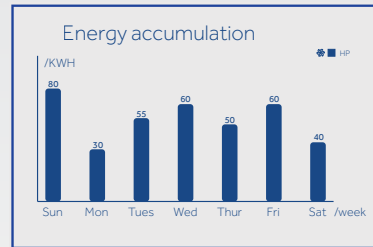
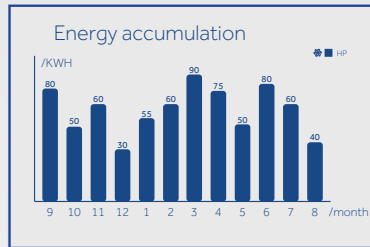

## Customizable Control Experience



### Mute Mode

In this mode, the heat pump operates quietly.



### Bactericidal Mode

Users can set the sterilization temperature, the frequency of sterilization, and the start time of sterilization.



### Personalized sterilization settings

- Set the sterilization temperature, which is adjustable from 55°C to 75°C.
- Set the frequency of sterilization, which can be selected as single, weekly, or monthly.
- Set the start time of sterilization, adjustable from 0 to 24 hours.



## ***EASY INSTALLATION FOR YOUR PEACE OF MIND***

The installation of the Haier EIP+ series air source heat pump water heater is quick and easy, thanks to its innovative design.





# ALL IN ONE INTEGRATED



## Elegant Design

The pure white body is aesthetic and fashion, while the shield-shaped display symbolizes security and reliability.



## Easy Installation

There is no need for additional refrigerant connection pipes or unnecessary pipelines, ensuring convenient installation.



# INSTALLATION INSTRUCTIONS

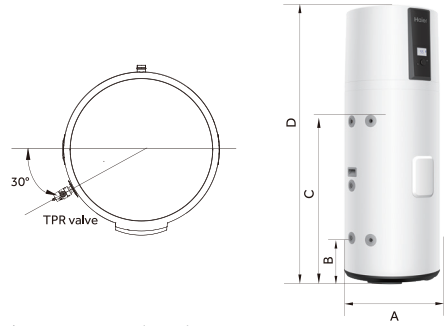
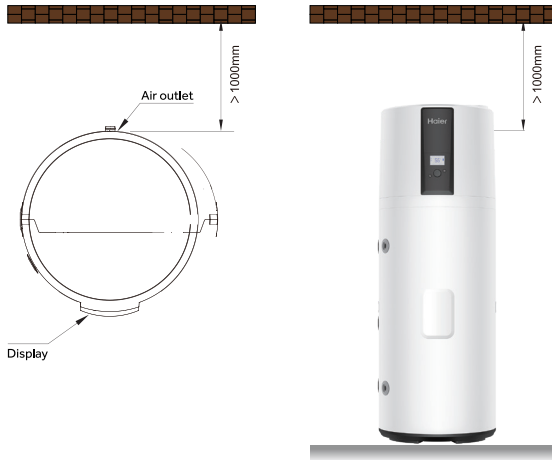

\*Dimensions (mm)

Model	A	B	C	D
HP200M7-F9	620	270	980	1694
HP250M7-F9	620	270	1275	1989
HP200M7C-F9	620	270	980	1694
HP250M7C-F9	620	270	1275	1989



Installation in an unheated room >15m<sup>2</sup>

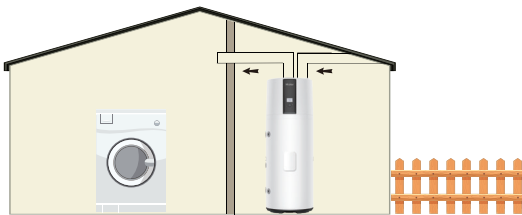

Installation with 2 ducts to the outside

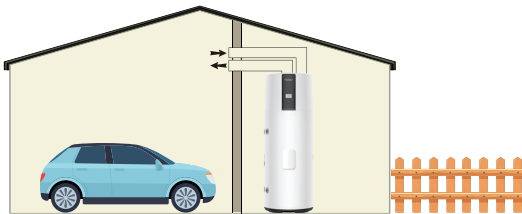

Installation with 2 ducts to an unheated room >15m<sup>2</sup>

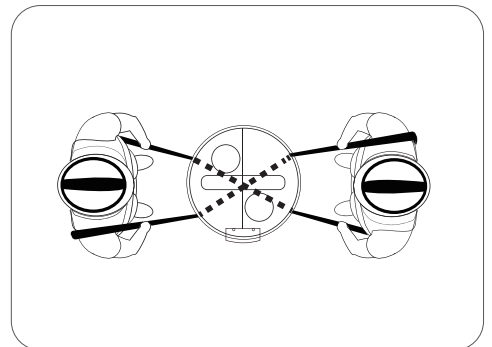
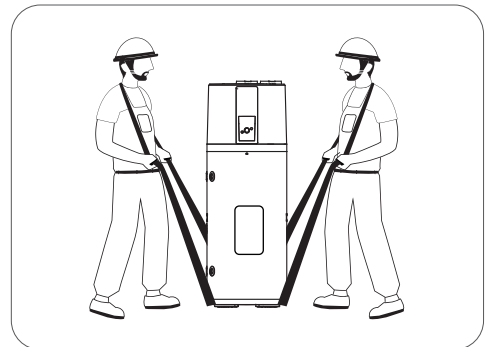

Lift the heat pump by two persons.



# COMPONENTS



1 Evaporator

2 Electronic expansion valve

3 Compressor

4 Enamel tank

5 Micro-channel condenser

6 Air channel

7 Four-way valve

8 DC fan

9 Display panel

10 Drain pan

11 Electric heating element

12 Coil condenser



# TECHNICAL PARAMETERS



R290



Micro-channel  
Condenser



Up to 65°C



Dual Power  
Heat



Child Lock



40dB



hOn App

Model	HP200M7-F9	HP200M7C-F9	HP250M7-F9	HP250M7C-F9
<b>Tank</b>				
Total cylinder capacity(L)	194	185	250	240
Rated voltage/frequency(V/Hz)	220-240/50	220-240/50	220-240/50	220-240/50
Tank Max pressure(kPa)	700	700	700	700
Corrosion protection	Magnesium rod	Magnesium rod	Magnesium rod	Magnesium rod
Insulation protection rating	IPX4	IPX4	IPX4	IPX4
<b>Performances(7°C/6°C ambient air temperature, 10°C/55°C water temperature)</b>				
COP@7°C(EN16147)	3.2	3.2	3.23	3.21
COP@14°C	3.6	3.6	3.6	3.6
Power input by electric backup(W)	1500	1500	1500	1500
Rated power input by heat pump(W)	320	320	320	320
Maximum power input by heat pump(W)	535	535	535	535
Maximum power input(W)	2035	2035	2035	2035
Heating water capacity(L/h)	24	24	24	24
Heating up time(10°C/55°C)@7°C(h)	7	6.8	10.5	10.3
Default temperature setting(°C)	65	65	65	65
Temperature setting range-with heater(°C)	35-75	35-75	35-75	35-75
Maximum temperature output for the heat pump only(°C)	65	65	65	65
Max working pressure of refrigerant(MPa)	1.0/3.3	1.0/3.3	1.0/3.3	1.0/3.3
Refrigerant type/weight(kg)	R290/0.15	R290/0.15	R290/0.15	R290/0.15
Sound power level *@1 metre(dB(A))	50	50	50	50
V40(L)	239	228	307	295
Ambient temperature for heat pump(°C)	-7-45	-7-45	-7-45	-7-45
<b>Dimension and connections</b>				
Water inlet and outlet connection	Rp 3/4	Rp 3/4	Rp 3/4	Rp 3/4
TPR valve connection	Rp 3/4	Rp 3/4	Rp 3/4	Rp 3/4
Drain & water inlet connection	Rp 3/4	Rp 3/4	Rp 3/4	Rp 3/4
Product dimensions(mm)	600*620*1694	600*620*1694	600*620*1989	600*620*1989
Packing dimension with pallet(mm)	736*695*1940	736*695*1940	736*695*2250	736*695*2250
Net/gross weight(kg)	86/109	96/119	98/121	107/131
Filled weight of the appliance(kg)	281	282	347	349

\*THE COP was measured under test conditions with an ambient air temperature of 20°C/15°C (Dry Bulb/Wet Bulb) and heating of the water from 15°C to 55°C during water heater operation.

\*The noise level was measured at 1 m from the water heater during a Noise Test conducted to Standard GB/T 23137 in a hemi-anechoic chamber with in a laboratory.

## BEYOND THE COMFORT



### ADDRESS

No.1 Haier Road, Qingdao 266101 P.R. China

### WEBSITE

[www.haier.com](http://www.haier.com)



The specifications, designs and information in this catalogue are subject to the actual products.  
Haier reserves the right to make changes without any notice.